

CASIO®

fx-7700G Owner's manual

POWER GRAPHIC
fx-7700G
Owner's manual

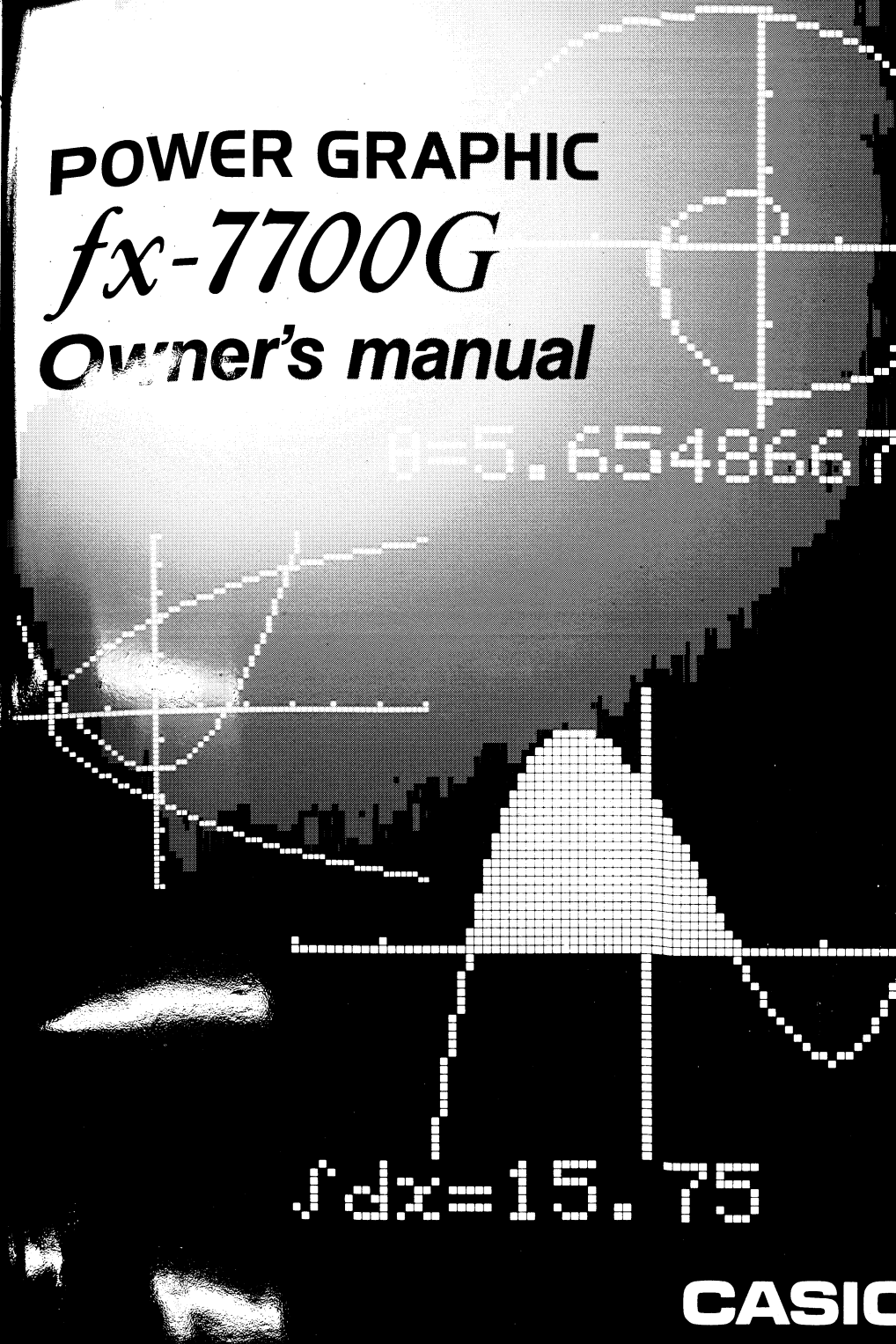

$\int dx = 15.75$

CASIO

U.S. Pat. 4,938,263/4,410,9

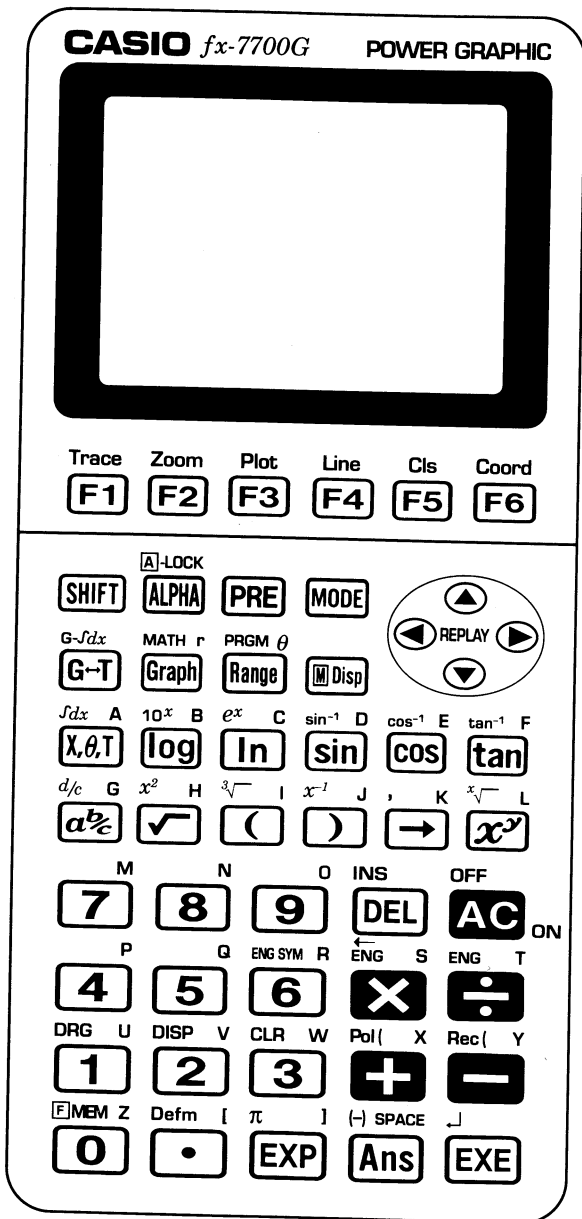

Quick-Start

Welcome to the world of Graphing Calculators and the Casio fx-7700G.

Quick-Start is not a complete tutorial, but it will take you through many of the most common functions, from turning the power on through graphing complex equations. When you're done, you'll have mastered the basic operation of the fx-7700G and will be ready to proceed with the rest of this manual to learn the entire spectrum of functions the fx-7700G can perform.

Each step of every example is shown graphically to help you follow along quickly and easily. For example, when you need to enter the number 57, we've indicated it as follows:

Press **5** **7**

Whenever necessary, we've included samples of what your screen should look like. If you find that your screen doesn't match the sample, or in fact you need to start over for any reason, you can do so by pressing the "All Clear" button. **AC**

POWER ON/OFF

To turn your unit on, press **AC** ON

To turn your unit off, press **SHIFT** **AC** OFF

NOTE: Your unit will automatically shut itself off after six minutes of inactivity.

ADJUSTING THE CONTRAST

1. Press **MODE**

The following screen will appear:

2. Press **◀** to lighten screen or **▶** to darken screen.

3. Press **AC** to clear the screen.

Sys mode	Cal mode
1: RUN	+: COMP
2: WRT	-: BASE-N
3: PCL	x: SD
REG model	÷: REG
4: LIN	0: MATRIX
5: LOG	Contrast
6: EXP	←: LIGHT
7: PWR	→: DARK

MODES

The fx-7700G features a variety of modes that enable you to perform specific functions. To begin this Quick-Start guide, you will need to set the correct system mode and calculation mode.

Setting the system mode

1. After turning the fx-7700G on, press **MODE**

The following screen will appear:

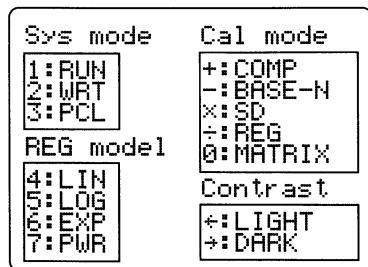

2. Press **1** which corresponds to RUN in the box labelled Sys mode.

The following screen or similar will appear:

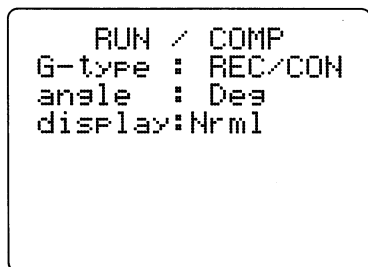

You are now in the RUN mode, where you can perform manual computations and produce graphs.

Setting the calculation mode

1. Press **MODE**
2. Press **+** which corresponds to COMP in the box labelled Cal mode.

You are now in the COMPUTATION mode, where you can perform general computations, including functional computation.

BASIC COMPUTATIONS

Unlike a regular calculator, which lets you see only one step of your problem at a time, the fx-7700G displays the entire problem on its large, computer-like screen. You enter problems just as you would write them, as you will see in the following example:

EXAMPLE: $15 \times 3 + 61$

1. Press **AC** to clear the screen.
2. Press **1** **5** **×** **3** **+** **6** **1** **EXE**

The answer will appear on the screen as follows:

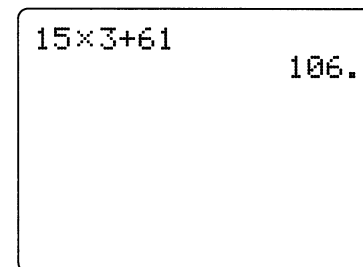

NOTE: In mixed arithmetic operations, the fx-7700G automatically gives priority to multiplication and division, and computes those operations before addition and subtraction.

Keep this problem displayed on your screen while you move on to the next example.

Grouping within an equation

You can also group certain operations within your equation using the parentheses keys. ()

EXAMPLE: $15 \times (3 + 61)$

1. Press **1** **5** **×** **(** **3**
+ **6** **1** **)** **EXE**

The following screen will appear:

$15 \times 3 + 61$	
$15 \times (3 + 61)$	106.
	960.

Note that your previous calculation remains on the screen. The new calculation is displayed beneath it for easy comparison.

Now let's try a variation on that problem by positioning the parentheses differently.

EXAMPLE: $(15 \times 3) + 61$

1. Press **(** **1** **5** **×** **3** **)**
+ **6** **1** **EXE**

The following screen will appear:

$15 \times 3 + 61$	
$15 \times (3 + 61)$	106.
$(15 \times 3) + 61$	960.
	106.

As you can see, the fx-7700G displays all three problems simultaneously.

USING BUILT-IN VALUES

The fx-7700G features several convenient built-in functions and values that you can enter into your equations quickly and easily.

EXAMPLE: $25 \times \text{sine of } 45$ (In Deg mode)

1. Press **AC**
 2. Press **2** **5** **×**
sin **4** **5**

$25 \times \sin 45$
17.67766953

3. Press **EXE** and the answer will appear on the screen as follows:

Using the Replay feature

With the replay feature, you can go back in and change any part of your equation at any time, even after the fx-7700G computes the answer, without having to rewrite the entire equation. We'll use the previous equation as an example. Let's say you need to change the sine of 45 to sine of 55, but everything else in the equation remains the same.

1. Press **◀** This will bring you back into the equation.
 2. Press **◀** twice so the flashing cursor is on the 4.

3. Press **5** to overwrite a 5.

$25 \times \sin 55$
20.47880111

4. Press **EXE** and the fx-7700G will quickly recompute the new solution:

FRACTIONS

The fx-7700G makes it easy to work with fractions with its fraction key. $\frac{a}{b/c}$ On screen, the $\frac{a}{b/c}$ symbol is entered between each value of the fraction. For example, $1^{15}/_{16} + 37/_9$

EXAMPLE: $1^{15}/_{16} + 37/_9$

1. Press **AC**
2. Press **1** $\frac{a}{b/c}$ **1** **5** $\frac{a}{b/c}$ **1** **6**
+ **3** **7** $\frac{a}{b/c}$ **9** **EXE**

The answer will appear on the screen as follows:

1.15.16+37.9
6.7.144.

Converting the answer to a decimal equivalent

With the answer still on your screen,

1. Press **EXE** $\frac{a}{b/c}$ and the decimal equivalent of your answer (6.048611111) will appear on the screen.

Converting the answer to an improper fraction

With the answer still on your screen,

1. Press **EXE** **SHIFT** $\frac{a}{b/c}$ and your answer (871.144) will appear on the screen in the form of an improper fraction.

EXPONENTIALS

Exponentials are another function the fx-7700G can perform quickly and easily.

EXAMPLE: 1250×2.06^5

1. Press **AC**
2. Press **1** **2** **5** **0**
× **2** **.** **0** **6**

3. Now you are ready to enter the exponent value. Press the exponent key x^y and x^y will appear on the screen. The number directly preceding the x , in this case 2.06, is the base number.

4. Press **5** The number 5 now appears after the x^y symbol, and represents the exponential value.

5. Press **EXE** and the answer will appear on the screen as follows:

1250 x 2.06 x^y 5
46370.96297

GRAPHING

The fx-7700G has the ability to present graphic solutions to a variety of complex equations. But before you can begin you must make sure you are in the correct GRAPH MODE:

Setting the graph mode

1. Press **AC** **MODE** **SHIFT** and the second mode screen will appear:
2. Press **+** which corresponds to REC in the box labelled Graph type, to set the graph mode to rectangular coordinate graph.
3. Press **MODE** **+** to set the COMP (computation) mode.

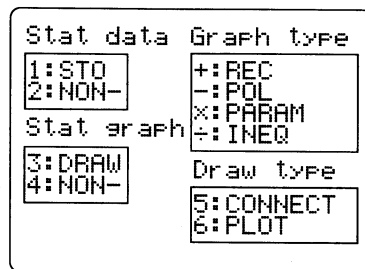

Graphing a built-in function

The fx-7700G can quickly create a graph of one of its built-in values or functions.

EXAMPLE: $y = \sin x$

4. Press **Graph**
5. Press **sin** (x is assumed)
6. Press **EXE** and the following graph will appear:

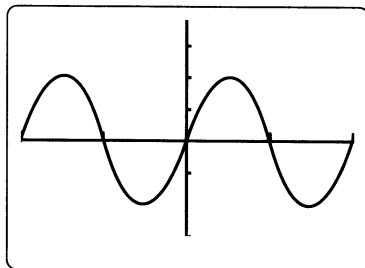

Returning to the equation

If you find that you need to return to your equation to change or replace certain values, you can do so simply by pressing the Graph-Text toggle key. **G↔T** The fx-7700G has two separate areas of its memory: one for your formula, the other for graphs.

1. Press **G↔T** once to see the equation, then again to see the graph.

Trace function

The trace function lets you select an exact point on the graph and display the coordinates of that point.

1. With the graph still on your screen, press **Trace** **F1**. The following screen will appear:

Trace
F1

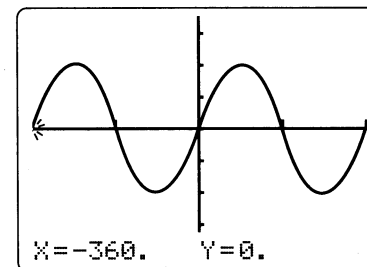

Notice that a cursor has appeared at the left-most point on the X axis and its coordinates have appeared at the bottom of the screen. Move the cursor to the right by pressing the **▶** key, then back to the left using the **◀** key. Pressing the button once will move the cursor one point, while holding it down will cause continuous movement. (The values may be approximated due to the space limitations of the screen.)

2. Press **Coord** **F6** to view the full value of the X coordinate in unabbreviated form.
3. Press **Coord** **F6** to view the full value of the Y coordinate in unabbreviated form.
4. Press **Coord** **F6** a third time to see both coordinates simultaneously.
5. Press **Trace** **F1** to exit the trace function.

Scrolling in four directions

1. Pressing any arrow key lets you scroll to see different sections of your graph.

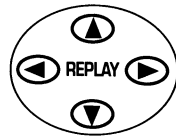

Returning to your original graph

After scrolling, you needn't retrace your steps to get back to your original graph. You can do it quickly and easily using the function keys (F keys) to enter a selection from one of the many FUNCTION MENUS the fx-7700G employs. A function menu is a group of up to 6 functions that are displayed across the bottom of the screen. To select one of the choices, press the corresponding F key.

2. Using the  key, scroll so the Y axis is at the left of the screen.

3. Press **Zoom** **F2** and the following screen will appear:

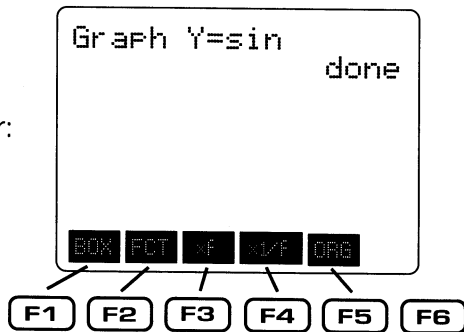

The first five function keys in the function menu each correspond to one of the five boxes along the bottom of the screen. (The sixth function key is inactive in this instance.) The one we'll concern ourselves with now is **F5** which corresponds to **ORG** (original) on the screen.

4. Press **F5** to bring you back to your original graph.

Zoom function

Another of the powerful graphing features of the fx-7700G is zooming. This allows you to enlarge a portion of your graph for detailed analysis, or zoom out for a broader view.

Zoom function cont'd

Zooming in

1. Press **F2**
The following screen will appear:



2. Press **F3** which corresponds to the **x^F** box on the screen, to zoom in on your graph. The screen will now show a view that is enlarged by a predetermined factor. (Later in the manual, you'll learn how to set your own factor of enlargement or reduction.)

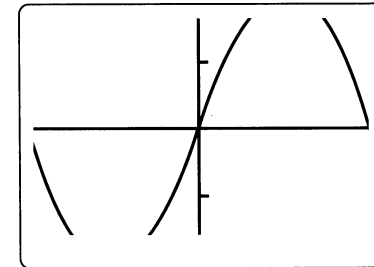

3. Press **F2** to show the zoom function menu.
4. Press **F5** to return to your original graph.

Zooming out

5. Press **F2** to show the zoom function menu.
6. Press **F4** which corresponds to **1/F** on the screen, to zoom away from the graph. The screen should now look like this:

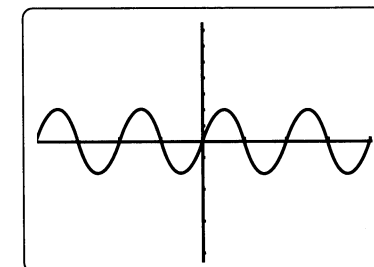

Using the Box function to zoom

This function lets you define any portion of the screen and magnify it for further analysis.

1. Press **F2** to display the zoom function menu.
2. Press **F1** which corresponds to **BOX** on the screen.

The following screen will appear:
Notice that the blinking cursor is at the origin.

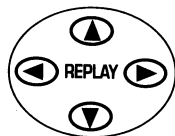
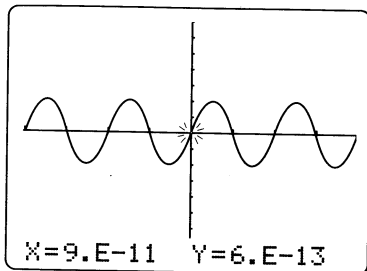

3. Using the arrow keys, move the cursor to a spot which will define one corner of the area, or "box," you wish to zoom in on.
4. Press **EXE** to "anchor" the cursor, creating the first corner of the box. Now, use the arrow keys to draw a box over the area you wish to enlarge.
5. Press **EXE** and the area you defined will enlarge to fill the entire screen.
6. Press **F2** to display the zoom function menu.
7. Press **PRE** twice to clear the zoom function menu.

INTEGRATION GRAPH

Setting the mode

1. Press **MODE** **SHIFT** **+** to set the graph mode to rectangular coordinates graph.

Setting the range

Before graphing an integral, you need to define the range of each axis by setting its maximum and minimum value. You also need to set the scale by which each axis will be divided. This is done as follows:

2. Press **AC** 3. Press **Range** to display the range input screen.
4. Set the X_{min} range to -5 by pressing **-** **5**
Press **EXE** and -5 will overwrite the existing value and move the cursor to the next value.
5. Set the X_{max} range to 10 by pressing **1** **0** **EXE**
6. Set the X_{sc1} (scale) to 5 by pressing **5** **EXE**
7. Set the Y_{min} range to -8 by pressing **-** **8** **EXE**
8. Set the Y_{max} range to 8 by pressing **8** **EXE**
9. Set the Y_{sc1} (scale) to 5 by pressing **5** **EXE**

The following screen will appear:

This second range screen is sometimes needed to set additional values. However, since none are necessary for this example, press **Range** to bypass the screen.

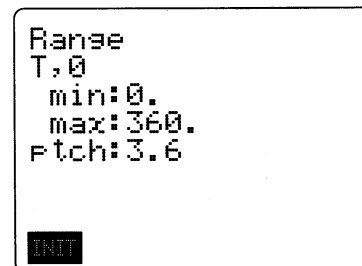

Creating the graph

An integration graph is just one of many types of graphs the fx-7700G can generate in just a few keystrokes.

EXAMPLE: $\int_1^5 (x-1)(x-5) dx$

10. Press **SHIFT** **G↔T**
11. Press **(** **X,θ,T** **-** **1** **)**
(**X,θ,T** **-** **5** **)**
SHIFT **→** **1** **SHIFT** **→** **5**

12. Press **EXE** and your graph will appear on screen as follows:
 (Shading is automatic)

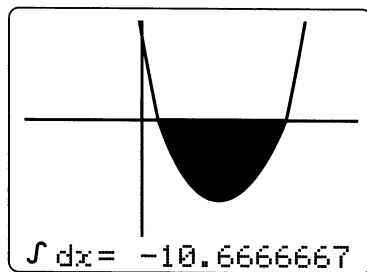

POLAR GRAPH

Setting the mode (In Rad mode)

1. Press **MODE** **SHIFT** **-** to set the graph mode to polar.

Setting the range

2. Press **AC**
3. Set the range parameters to match the following screen.
 Remember to press **EXE** after each value to move the cursor to the next field.
 If you have trouble, refer back to page XIII.

```

Range
Xmin:-12.
max:12.
scl:2.
Ymin:-8.
max:8.
scl:2.
INIT
    
```

Polar graph cont'd

3. This time, we will also need to enter values in the second range screen. Set those to match the screen to the right.

Remember to press **EXE** after each value is entered.

```

Range
T,θ
min:0.
max:3π.
Pch:π÷36
INIT
    
```

Creating the graph

EXAMPLE: $r = \theta$

4. Press **Graph** **X,θ,T** **EXE** and the graph will appear on the screen as follows:

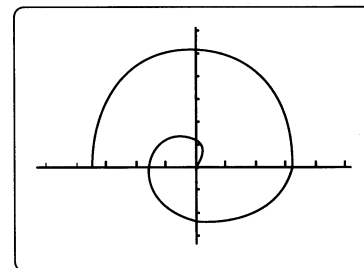

INEQUALITY GRAPH

Setting the mode

1. Press **MODE** **SHIFT** **÷** to set the graph mode to inequality.

Setting the range

2. Press **AC**
3. Set the range parameters to match the following screen.
 Remember to press **EXE** after each value to move the cursor to the next field.
 When the second range screen appears, press **Range** to bypass it, as again it is unnecessary for this example.

```

Range
Xmin:-5.
max:10.
scl:5.
Ymin:-15
max:10
scl:5.
INIT
    
```

Quick-Start

Creating the graph

EXAMPLE: $y > x^2 - 5x - 5$
 $y < x - 2$

3. Press **Graph** and the following screen will appear:

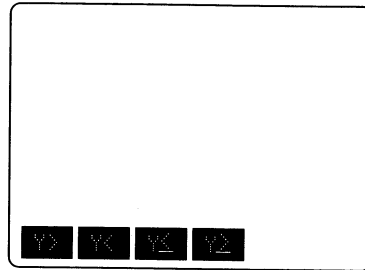

4. Press **F1** which corresponds to the Y> box on the screen.

5. Press **X,θ,T** **SHIFT** $\sqrt{\quad}$
- **5** **X,θ,T**
- **5** **EXE**

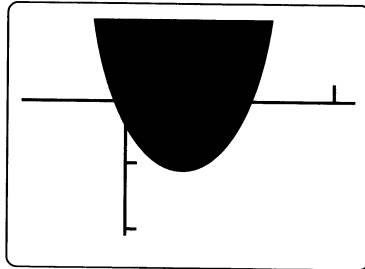

The following screen will appear:

6. Press **Graph** to enter the next inequality.

7. Press **F2** which corresponds to the Y< box on the screen.

8. Press **X,θ,T** **-** **2**

EXE The following screen will appear:

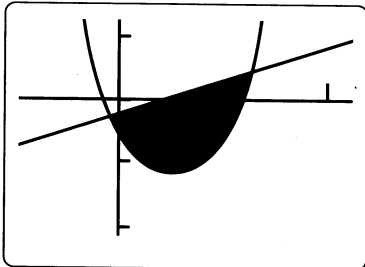

If you've completed this Quick-Start section, you are well on your way to becoming an expert user of the Casio fx-7700G Power Graphic Calculator.

To learn all about the many powerful features of the fx-7700G, read on and explore!

POWER GRAPHIC fx-7700G

Power Graphic

Contents

Handling Precautions.....	7
About This Manual	8
Chapter 1 Getting Acquainted	9
1-1 Keys and Their Functions.....	10
The Keyboard	11
Key Operations	11
1-2 Modes	17
Using the Mode Menus to Change Modes	17
1-3 Basic Set Up.....	20
To specify the Unit of Angular Measurement.....	20
To specify the Display Format	20
To specify the Engineering Mode	21
To specify the Number of Decimal Places.....	22
To specify the Number of Significant Digits.....	23
To adjust the Contrast of the Display.....	23
1-4 Basic Operation	24
Using the Clear Menu	24
Inputting Calculations	25
Editing Calculations	26
Answer Function	28
Using Multistatements	29
Multiplication Operations without a Multiplication Sign	30
Performing Continuous Calculations	30
Using the Replay Function.....	31
Engineering Symbols.....	32
Scientific Functions.....	33
Value Memories.....	35
Increasing the Number of Value Memories	36
About memory names.....	37
1-5 Using the Base-N Mode	38
1-6 Using the Matrix Mode	41
About Matrices.....	41
Performing Matrix Arithmetic Operations.....	44
Other Matrix Operations	47

Contents

1-7 Using the Function Memory	57
1-8 Graphic and Text Displays	60
1-9 Technical Information	61
Calculation Priority Sequence.....	61
Stacks	62
Value Input and Output Limitations.....	63
Steps.....	63
Overflow and Errors.....	64
Exponential Display	64
Chapter 2 Manual Calculations	67
2-1 Arithmetic Calculations	68
Calculations Using Parentheses.....	69
2-2 Units of Angular Measurement	70
2-3 Trigonometric and Inverse Trigonometric Functions	71
2-4 Logarithmic and Exponential Functions	72
2-5 Hyperbolic and Inverse Hyperbolic Functions	73
2-6 Other Functions.....	74
2-7 Coordinate Conversion.....	75
2-8 Permutation and Combination	76
2-9 Fractions	77
2-10 Engineering Symbol Calculations	78
2-11 Number of Decimal Places, Number of Significant Digits, Display Format	79
2-12 Calculations Using Memory	80
2-13 Base-N Mode Calculations	81
Conversions.....	81
Negative Values.....	81
Arithmetic Operations	81
Logical Operations.....	82
Chapter 3 Integration Calculations	83
3-1 How the Unit Calculates Integrations	84
To perform an integration calculation	85
Application of integration calculation	86

Chapter 4	Statistical Calculations	89
4-1	Single-Variable Statistical Calculations	90
	To enter the Standard Deviation Mode without data storage	90
	To enter the Standard Deviation Mode with data storage	92
4-2	Paired-Variable Statistical Calculations	97
	To enter the Regression Mode without data storage	97
	To enter the Linear Regression Mode	98
	To enter the Logarithmic Regression Mode.....	100
	To enter the Exponential Regression Mode	101
	To enter the Power Regression Mode	102
	To enter the Regression Mode with data storage	103
4-3	Things to Remember during Statistical Calculations	104
4-4	Examples of Statistical Calculations	105
	Linear Regression.....	107
	Logarithmic Regression	108
	Exponential Regression.....	109
	Power Regression	110
Chapter 5	Graphing	111
5-1	About the Graphing Function	112
	Specifying the Range of a Graph.....	112
5-2	Rectangular Coordinate Graphs	118
	Graphing Built-in Scientific Functions	118
	Overdrawing Built-in Function Graphs.....	119
	Graphing Manually Entered Functions	120
	Overdrawing Manually Input Graphs	120
	Specifying the Value Range	121
5-3	Polar Coordinate Graphs	122
	Graphing Manually Entered Functions	123
	Specifying the Value Range	124
5-4	Parametric Graphs	125
	Specifying the Value Range	126
5-5	Inequality Graphs	127
	Overdrawing Inequality Graphs	128
	Specifying the Value Range	129
5-6	Integration Graphs	130

5-7	Probability Distribution Graphs	131
5-8	Single-Variable Statistical Graphs	133
5-9	Paired-Variable Statistical Graphs	136
5-10	Other Graph Functions	138
	Connect Type and Plot Type Graphs	138
	Trace Function.....	138
	Scrolling Graphs	142
	Notes on Using the Trace Function	143
	Plot Function.....	144
	Line Function	146
	Graph Scroll Function.....	148
	Zoom Functions	150
	Box Function.....	150
	Using the Factor Function to Enlarge and Reduce the Entire Graph	153
5-11	Some Graphing Examples	160
Chapter 6	Programming	163
6-1	Introduction to Programming	164
	To enter the Programming Mode.....	164
	To scroll through program area names.....	165
	To check how much memory is used by a program	165
	To input a program	166
	To execute a program stored in memory.....	167
	To edit a program	170
	To delete a specific program	171
	To clear all programs	172
6-2	About Error Messages	173
6-3	Counting the Number of Steps	174
	To check the amount of memory remaining	174
	To check where the cursor is currently located	174
6-4	Program Commands	175
	To display the Program Function Menu.....	175
	About the Newline Function.....	176
	To display the Jump Command Menu	176
	To display the Relational Operator Menu	177
	To display the Punctuation Symbol Menu	177

Contents

6-5 Using Jump Commands	178
About Unconditional Jumps	178
About Conditional Jumps	179
About Count Jumps	180
6-6 Using Subroutines	182
Subroutines save memory	183
6-7 Using Array Memory	184
Array Memories Simplify Programming	184
Cautions When Using Array Memories	185
Sample Programs that Use Array Memory	186
6-8 Displaying Text Messages	188
6-9 Using the Graph Function in Programs	190
Appendix	193
Appendix A Power Supply	194
When to Replace Batteries	194
Replacing Batteries	195
About the Auto Power Off Function	197
Appendix B To Reset the Calculator	198
Appendix C Function Reference	199
Manual Calculations	199
Program Calculations	203
Appendix D Error Message Table	205
Appendix E Input Ranges	207
Appendix F Specifications	208
Index	211
Key Index	215

Handling Precautions

- Your calculator is made up of precision components. Never try to take it apart.
- Avoid dropping your calculator and subjecting it to other strong impacts.
- Do not store the calculator or leave it in areas exposed to high temperatures or humidity, or large amounts of dust. When exposed to low temperatures, the calculator may require more time to display results and may even fail to operate. Correct operation will resume once the calculator is brought back to normal temperature.
- The display will go blank and keys will not operate during calculations. When you are operating the keyboard, be sure to watch the display to make sure that all your key operations are being performed correctly.
- Replace batteries once every 5 years regardless of how much the calculator is used during that period. Never leave dead batteries in the battery compartment. They can leak and damage the unit.
- Avoid using volatile liquids such as thinner or benzene to clean the unit. Wipe it with a soft, dry cloth, or with a cloth that has been dipped in a solution of water and a neutral detergent and wrung out.
- In no event will the manufacturer and its suppliers be liable to you or any other person for any damages, expenses, lost profits, lost savings or any other damages arising out of loss of data and/or formulas arising out of malfunction, repairs, or battery replacement. The user should prepare physical records of data to protect against such data loss.
- Never dispose of batteries, the liquid crystal panel, or other components by burning them.
- When the "Low battery" message appears on the display, replace the main power supply batteries as soon as possible.
- Be sure that the power switch is set to OFF when replacing batteries.
- If the calculator is exposed to a strong electrostatic charge, its memory contents may be damaged or the keys may stop working. In such a case, perform the All Reset operation to clear the memory and restore normal key operation.
- Note that strong vibration or impact during program execution can cause execution to stop or can damage the calculator's memory contents.
- Using the calculator near a television or radio can cause interference with TV or radio reception.
- Before assuming malfunction of the unit, be sure to carefully reread this manual and ensure that the problem is not due to insufficient battery power, programming or operational errors.

Important

In no event shall Casio Computer Co., Ltd. be liable to anyone for special, collateral, incidental, or consequential damages in connection with or arising out of the purchase or use of these materials. Moreover, Casio Computer Co., Ltd. shall not be liable for any claim of any kind whatsoever against the use of these materials by any other party.

- The contents of this manual are subject to change without notice.
- No part of this manual may be reproduced in any form without the express written consent of the manufacturer.

About This Manual.....

This manual is divided into chapters to help you find the operation you want quickly and easily.

Chapter 1 Getting Acquainted

This chapter gives you a general introduction to the various capabilities of the unit. It contains important information about the unit, so you should be sure to read it before starting operation.

Chapter 2 Manual Calculations

Manual calculations are those that you input manually, as on the simplest of calculators. This chapter provides various examples to help you become familiar with the manual calculations.

Chapter 3 Integration Calculations

This chapter tells you how to perform integration calculations on the unit.

Chapter 4 Statistical Calculations

This chapter tells you how to perform single-variable statistical calculations performed using standard deviation, and paired-variable statistical calculations performed using regression. No matter what type of statistical calculations you decide to perform, you can tell the unit to either store the statistical data or not to store the data.

Chapter 5 Graphing

This chapter explains everything you need to know to fully use the versatile graphing capabilities of the unit.

Chapter 6 Programming

This chapter tells you how to use the program memory of the unit. Once you program a calculation, you can call it up and execute it using any values you want at the touch of a key.

Appendix

The appendix contains information on battery replacement, error messages, specifications, and other technical details.

Important

Reset your calculator before using it for the first time!

See page 198 for details on the reset procedure.

Be sure to keep physical records of all important data!

The large memory capacity of the unit makes it possible to store large amounts of data. You should note, however, that low battery power or incorrect replacement of the batteries that power the unit can cause the data stored in memory to be corrupted or even lost entirely. Stored data can also be affected by strong electrostatic charge or strong impact.

Chapter

1

Getting Acquainted

- 1-1 Keys and Their Functions
- 1-2 Modes
- 1-3 Basic Set Up
- 1-4 Basic Operation
- 1-5 Using the BASE-N Mode
- 1-6 Using the Matrix Mode
- 1-7 Using the Function Memory
- 1-8 Graphic and Text Displays
- 1-9 Technical Information

This chapter gives you a general introduction to the various capabilities of the unit. It contains important information about the unit, so you should be sure to read it before starting operation.

1-1 Keys and Their Functions

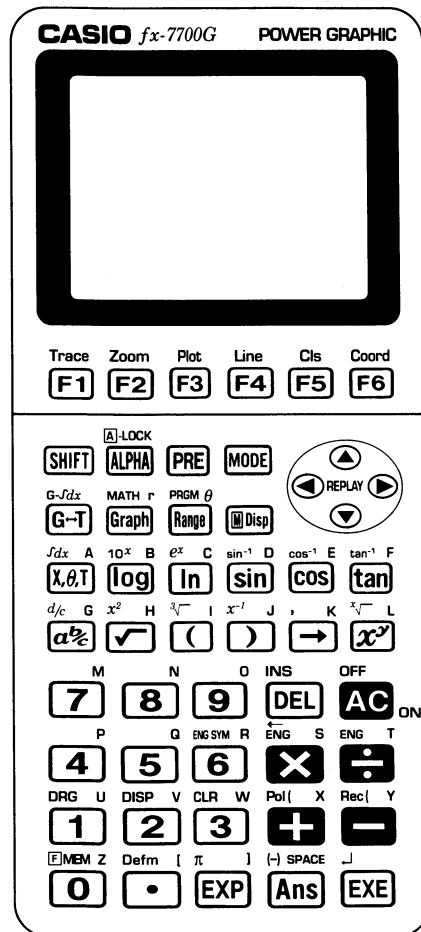

■ The Keyboard

Many of the unit's keys are used to perform more than one function. The functions marked on the keyboard are color coded to help you find the one you need quickly and easily.

Shifted function— 10^x B—Alpha function
 Primary function—**log**

● Primary Functions

These are the functions that are normally executed when you press the key.

● Shifted Functions

You can execute these functions by first pressing the **SHIFT** key, followed by the key that is assigned the shifted function you want to execute.

● Alpha Functions

An alpha function is actually the simple input of an alphabetic letter. Press the **ALPHA** key, followed by the key that is assigned the letter you want to input.

Alpha Lock

Normally, once you press **ALPHA** and then a key to input an alphabetic character, the keyboard reverts to its primary functions immediately. If you press **SHIFT** and then **ALPHA**, the keyboard locks in alpha input until you press **ALPHA** again.

■ Key Operations

Trace Coord
F1 ~ **F6** **Function Keys**

- Use these keys to select functions from the menus that appear on the display.

SHIFT Shift Key

- Press this key to shift the keyboard and access the functions marked in orange (or green). The **S** indicator on the display indicates that the keyboard is shifted. Pressing **SHIFT** again unshifts the keyboard and clears the **S** indicator from the display.
- This key is also used during display of a Mode Menu to advance to the next Mode Menu screen.

ALPHA Alpha Key

- Press this key to input a letter marked in pink on the keyboard.
- Press this key following **SHIFT** to lock the keyboard into alphabetic character input. To return to normal input, press **ALPHA** again.

PRE Previous Key

- Use this key to backtrack through menus.

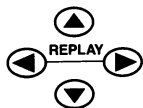

Cursor/Replay Keys

- Use these keys to move the cursor on the display.
- After you press the **EXE** key following input of a calculation or value, press **◀** to display the calculation from the end, or **▶** to display it from the beginning. You can then execute the calculation again, or edit the calculation and then execute it. See page 31 for details on the Replay Function.

MODE Mode Key

- Press this key to display the Mode Menu.

G/T Graph-Text Key

- Press this key to switch between the graph and text screens.
- Press this key following **SHIFT** before entering data for graphing of an integral.

MATH **r** Graph Key

- Press this key before entering a calculation formula for graphing.
- Press this key following **SHIFT** to display the input screen for functions. For full details on this operation, see page 33.

PRGM **θ** Range Key

- Use this key to set or check the range of a graph.
- Press this key following **SHIFT** to display the input screen for program commands. For full details on this operation, see page 167.
- Press this key following **ALPHA** to enter the letter θ .

MI-Disp Mode Display Key

- Use this key to check the current calculation mode settings. The mode settings remain displayed while this key is depressed.

X,θ,T Variable Key

- Press this key to input variables X, θ , and T when setting up a graph.
- Press this key following **SHIFT** to input variables for integration calculations.
- Press this key following **ALPHA** to enter the letter A.

10^x **B** Common Logarithm/Antilogarithm Key

- Press this key and then enter a value to calculate the common logarithm of the value.
- Press **SHIFT** **10^x** and then enter a value to make the value an exponent of 10.
- Press this key following **ALPHA** to enter the letter B.

e^x **C** Natural Logarithm/Exponential Key

- Press this key and then enter a value to calculate the natural logarithm of the value.
- Press **SHIFT** **e^x** and then enter a value to make the value an exponent of e.
- Press this key following **ALPHA** to enter the letter C.

sin⁻¹ **D** **cos⁻¹** **E** **tan⁻¹** **F** Trigonometric Function Keys

sin

- Press this key and then enter a value to calculate the sine of the value.
- Press this key following **ALPHA** to enter the letter D.

cos

- Press this key and then enter a value to calculate the cosine of the value.
- Press this key following **ALPHA** to enter the letter E.

tan

- Press this key and then enter a value to calculate the tangent of the value.
- Press this key following **ALPHA** to enter the letter F.

SHIFT **sin**

- Perform this operation and then enter a value to calculate the inverse sine of the value.

SHIFT **cos**

- Perform this operation and then enter a value to calculate the inverse cosine of the value.

SHIFT **tan**

- Perform this operation and then enter a value to calculate the inverse tangent of the value.

d/c **G**

a/b Fraction Key

- Use this key when entering fractions and mixed fractions. To enter the fraction 23/45, for example, press 23 **a/b** 45. To enter 2-3/4, press 2 **a/b** 3 **a/b** 4.
- Press **SHIFT** **a/b** to display an improper fraction.
- Press this key following **ALPHA** to enter the letter G.

x² **H**

√ Square Root/Square Key

- Press this key to calculate the square root of the next value you enter.
- Enter a value and then press **SHIFT** **x²** to square the entered value.
- Press this key following **ALPHA** to enter the letter H.

∛ **I**

□ Open Parenthesis/Cube Root Key

- Press this key to enter an open parenthesis in a formula.
- Press **SHIFT** **∛** and then enter a value to calculate the cube root of the value.
- Press this key following **ALPHA** to enter the letter I.

x⁻¹ **J**

) Close Parenthesis/Reciprocal Key

- Press this key to enter a close parenthesis in a formula.
- Press **SHIFT** **)** and then enter a value to calculate the reciprocal of the value.
- Press this key following **ALPHA** to enter the letter J.

→ **K**

→ Assignment/Comma Key

- Press this key before entering a value memory name to assign the result of a calculation to the value memory.
- Press this key following **SHIFT** to input a comma.
- Press this key following **ALPHA** to enter the letter K.

Power/Root Key

- Enter a value for x , press this key, and then enter a value for y to calculate x to the power of y .
- Enter a value for x , press **SHIFT** [key], and then enter a value for y to calculate the x th root of y .
- Press this key following **ALPHA** to enter the letter L.

Numeric Keys and Decimal Key

- Use the numeric keys to enter a value. Enter decimals using the decimal key.
- Following operation of the **ALPHA** key, each of the numeric keys enters the following letters.

- ALPHA** [7] enters M.
- ALPHA** [8] enters N.
- ALPHA** [9] enters O.
- ALPHA** [4] enters P.
- ALPHA** [5] enters Q.
- ALPHA** [6] enters R.
- ALPHA** [1] enters U.
- ALPHA** [2] enters V.
- ALPHA** [3] enters W.
- ALPHA** [0] enters Z.
- ALPHA** [.] enters the open bracket [.

- Following operation of the **SHIFT** key, the menus marked in orange (or green) above these keys are accessed.

SHIFT [MEM] — **Function Memory Menu**

This key operation displays the menu used for function memory calculations (see page 57).

SHIFT [DRG] — **Unit of Angular Measurement Menu**

This key operation displays the menu used for specification of the unit of angular measurement.

SHIFT [DISP] — **Display Format Menu**

This key operation displays the menu used for specification of the display format for calculation results.

SHIFT [CLR] — **Clear Menu**

This key operation displays the menu used for clearing memory contents.

SHIFT [ENG SYM] — **Engineering Symbol Menu**

This key operation displays the menu used for assignment of engineering symbols to values.

SHIFT [Defm] [EXE]

This key sequence displays the status of the program, function, variable, statistic (SD and LR), and matrix memories, along with the remaining number of steps.

For full details on each menu, see the section titled “Basic Set Up”, starting from page 20.

AC ^{OFF} _{ON} — **All Clear/ON/OFF Key**

- Press this key to switch power on.
- Press this key while power is on to clear the display.
- Press this key following **SHIFT** to switch power off.

DEL ^{INS} — **Delete/Insert Key**

- Press this key to delete the character at the current cursor location.
- Press **SHIFT** [INS] to display the insert cursor ([]). You can insert characters while the insert cursor is displayed.

+ **-** **×** **÷** **ENG** **S** **ENG** **T** — **Arithmetic Operation Keys**

- Input addition, subtraction, multiplication, and division calculations as they are written, from left to right. Press the applicable key to specify an arithmetic operation.
- You can also use the **+** and **-** keys to specify positive and negative values.
- Following operation of the **ALPHA** key, each of these keys enters the following letters.

- ALPHA** [×] enters S.
- ALPHA** [÷] enters T.
- ALPHA** [+] enters X.
- ALPHA** [-] enters Y.

- Following operation of the **SHIFT** key, the functions marked in orange above these keys are accessed.

SHIFT [Pol] — **Coordinate Transformation**

Use this operation when transforming rectangular coordinates into polar coordinates.

SHIFT [Rec] — **Coordinate Transformation**

Use this operation when transforming polar coordinates into rectangular coordinates.

SHIFT [ENG] — **Engineering Right**

Each time you perform this operation, the decimal of the displayed value shifts three decimal places to the right. This results in conversion of the displayed value from one International System unit to another, as shown in the following table.

Power	Prefix	Symbol
10^{18}	exa	E
10^{15}	peta	P
10^{12}	tera	T
10^9	giga	G
10^6	mega	M
10^3	kilo	k
10^{-3}	milli	m
10^{-6}	micro	μ
10^{-9}	nano	n
10^{-12}	pico	p
10^{-15}	femto	f

Example 12.3456 **EXE**

- 1st operation of **SHIFT** **ENG**
- 2nd operation of **SHIFT** **ENG**
- 3rd operation of **SHIFT** **ENG**
- 4th operation of **SHIFT** **ENG**

12.3456
12.3456E+00
12345.6E-03
12345600.E-06
12345600.E-06

(No change)

SHIFT **ENG** — **Engineering Left**

Each time you perform this operation, the decimal of the displayed value shifts three decimal places to the left. This results in conversion of the displayed value from one International System unit to another, as shown in the table above.

Example 12.3456 **EXE**

- 1st operation of **SHIFT** **ENG**
- 2nd operation of **SHIFT** **ENG**
- 3rd operation of **SHIFT** **ENG**
- 4th operation of **SHIFT** **ENG**

12.3456
0.0123456E+03
0.000012345E+06
0.000000012E+09
0.000000012E+09

(No change)

π **EXP** **Exponent/Pi Key**

- Use this key when entering a mantissa and exponent. To input 2.56×10^{34} , for example, enter 2.56 **EXP** 34.
- Press **SHIFT** **[π]** to input the value of π .
- Press this key following **ALPHA** to enter the closed bracket **]**.

ANS **Answer/(-) Key**

- Press this key to recall the most recent calculation result obtained using the **EXE** key.
- Press **SHIFT** **[(-)]** when entering a negative value.
- Press this key following **ALPHA** to enter space.

EXE **Execute/Newline Key**

- Press this key to obtain the result of a calculation. You can press this key following data input, or after a result is obtained to execute the calculation again using the previous result.
- Press **SHIFT** **[↵]** to perform a newline operation.

1-2 Modes

You can control the operations of the unit by setting certain parameters, which we call *modes*. When you press the **AC/ON** key and switch power on, the display should appear somewhat like the following illustration.

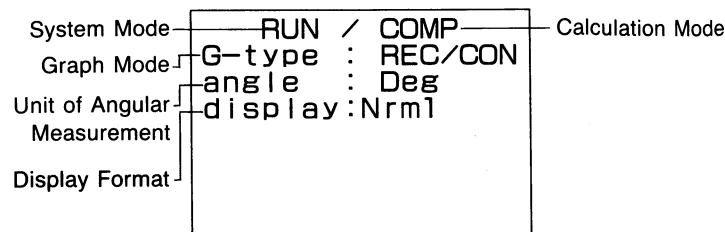

■ Using the Mode Menus to Change Modes

There are two mode menus that you can use to change modes. The following explains the content of the menu. The operations that you should perform to change the modes can be found in the applicable sections of this manual.

● To display Mode Menu 1

Press **MODE**.

Sys mode	Cal mode
1: RUN	+: COMP
2: WRT	-: BASE-N
3: PCL	x: SD
REG mode	÷: REG
4: LIN	∅: MATRIX
5: LOG	Contrast
6: EXP	←: LIGHT
7: PWR	→: DARK

Each of the values and symbols to the left of the mode names stands for key. To select a mode or operation, press the corresponding key.

Sys mode

1: RUN

Use this mode for manual calculations and program execution.

2: WRT

Use this mode for writing or checking programs.

3: PCL

Use this mode to clear programs from memory.

REG model

4: LIN

Use this mode for linear regression.

5: LOG

Use this mode for logarithmic regression.

6: EXP

Use this mode for exponential regression.

7: PWR

Use this mode for power regression.

Cal mode

+ : COMP

Use this mode for arithmetic calculations and function calculations. Programs can be executed in this mode.

- : BASE-N

Use this mode for binary, octal, and hexadecimal calculations and conversions.

× : SD

Use this mode for standard deviation calculations.

÷ : REG

Use this mode for regression calculations.

0 : MATRIX

Use this mode for matrix calculations.

Contrast

← : LIGHT

Press the ◀ key to make the display lighter.

→ : DARK

Press the ▶ key to make the display darker.

● To display Mode Menu 2

Press **MODE** **SHIFT**.

Stat data	Graph type
1:STO	+:REC
2:NON-	-:POL
Stat graph	x:PARAM
3:DRAW	÷:INEQ
4:NON-	Draw type
	5:CONNECT
	6:PLOT

Stat data

1: STO

Use this mode to store statistical data as it is input.

2: NON-

Use this mode if you do not want to store statistical data as it is input.

Stat graph

3: DRAW

Use this mode to draw a statistical graph.

4: NON-

Use this mode if you do not want to draw a statistical graph.

Graph type

+ : REC

Use this mode to draw graphs with rectangular coordinates.

- : POL

Use this mode to draw graphs with polar coordinates.

× : PARAM

Use this mode to graph parametrics.

÷ : INEQ

Use this mode to graph inequalities.

Draw type

5: CONNECT

Use this mode to connect the points plotted on the graph.

6: PLOT

Use this mode to plot individual (unconnected) points.

● To clear the Mode Displays

Press **MODE** again.

1-3 Basic Set Up

■ To specify the Unit of Angular Measurement

Example To set the unit of angular measurement as degrees

SHIFT DRG

Deg Rad Gra 0 r g

F1

F1 (Deg) EXE

Deg 0.

The following are the units of angular measurement that are available with the unit.

DEG (degrees)	360°	90°
RAD (radians)	2π	π/2
GRA (grads)	400	100

■ To specify the Display Format

SHIFT DISP

Fix Sci Nrm Eng

F3

F3 (Nrm)

Norm_

EXE

Norm 0.

Each time you press SHIFT DISP F3 (Nrm) EXE, the display format changes between Norm 1 and Norm 2. See page 64 for full details on Norm 1 and Norm 2.

Important

The above specification is applied to the displayed value only. The calculator still stores the entire 13-digit mantissa and 2-digit exponent of the result in memory. If you change the display format specification while a calculation result is displayed, the display changes to show the value using your new specification.

Example To perform $1 \div 200$ with Norm 1, and then change to Norm 2

1 ÷ 200 EXE

1 ÷ 200 5. E-03

Norm 1

SHIFT DISP F3 (Nrm) EXE

Norm 0.005

Norm 2

SHIFT DISP F3 (Nrm) EXE

Norm 5. E-03

Norm 1

■ To specify the Engineering Mode

SHIFT DISP

Fix Sci Nrm Eng

F4

F4 (Eng)

Eng_

EXE

Eng 5. m

Each time you press SHIFT DISP F4 (Eng) EXE, the unit enters or exits the Engineering Mode.

Important

The above specification is applied to the displayed value only. The calculator still stores the entire 13-digit mantissa and 2-digit exponent of the result in memory. If you change the engineering mode specification while a calculation result is displayed, the display changes to show the value using your new specification.

Example To perform $1 \div 500$ in Norm 1, and then change to the Engineering Mode

AC 1 ÷ 500 EXE

1 ÷ 500 2. E-03

SHIFT DISP

Fix Sci Nrm Eng

F4

F4 (Eng) EXE

Eng 2. m

F4 (Eng) EXE

Eng 2. E-03

■ To specify the Number of Decimal Places

Example To set the number of decimal places to 2

SHIFT DISP	Fix Sci Nrm Eng
	F1
F1(Fix) 2	Fix 2_
EXE	Fix 2 0.00

Now all displayed values will be rounded off to the nearest integer at the second decimal place.

Important

The above specification is applied to the displayed value only. The calculator still stores the entire 13-digit mantissa and 2-digit exponent of the result in memory. If you change the number of decimal places specification while a calculation result is displayed, the display changes to show the value using your new specification.

Example To perform $100 \div 7$ with 2 decimal places, and then change to 5 decimal places

AC 1 0 0 ÷ 7 EXE	100 ÷ 7 14.29
SHIFT DISP	Fix Sci Nrm Eng
	F1
F1(Fix) 5 EXE	Fix 5 14.28571

Note)

No matter what settings are currently being applied for the number of decimal places, pressing SHIFT DISP F3 (Nrm) EXE returns to the Norm mode (1 or 2).

■ To specify the Number of Significant Digits

Example To set the number of significant digits to 3

SHIFT DISP	Fix Sci Nrm Eng
	F2
F2(Sci) 3	Sci 3_
EXE	Sci 3 0.00E+00

Now all displayed values will be shown with 3 significant digits.

Important

The above specification is applied to the displayed value only. The calculator still stores the entire 13-digit mantissa and 2-digit exponent of the result in memory. If you change the number of significant digits specification while a calculation result is displayed, the display changes to show the value using your new specification.

Example To perform 123×456 with 3 significant digits, and then change to 4 significant digits

AC 1 2 3 X 4 5 6 EXE	123x456 5.61E+04
SHIFT DISP	Fix Sci Nrm Eng
	F2
F2(Sci) 4 EXE	Sci 4 5.609E+04

Note)

No matter what settings are currently being applied for the number of significant digits, pressing SHIFT DISP F3 (Nrm) EXE returns to the Norm mode (1 or 2).

■ To adjust the Contrast of the Display

MODE

- ◀ to make display lighter
- ▶ to make display darker

Important

If the display remains dim even when you adjust the contrast, you should replace batteries as soon as possible.

1-4 Basic Operation

The operations described here are fundamental calculations that you need to get started with the unit. Graphing, programming, and statistical calculations are covered in their own separate sections.

■ Using the Clear Menu

The Clear Menu lets you clear either the entire memory of the unit or specific parts of the memory.

Important

- The procedures described below cannot be undone. Make sure that you do not need data any more before you delete it.
- You can call up the Clear Menu while the unit is in any mode.

• To clear the entire memory

SHIFT CLR

McI Sci ARR PRG

F1

F1 (McI)

Mc I _

EXE

Mc I 0.

This operation clears all of the value memories, as well as any values assigned to r , θ , and variables.

• To clear statistical memories only

SHIFT CLR

McI Sci ARR PRG

F2

F2 (Sci)

Sc I _

EXE

Sc I 0.

This operation clears any values assigned to Σx^2 , Σx , n , Σy^2 , Σy , and Σxy .

• To clear matrix memory

SHIFT CLR

McI Sci ARR PRG

F3

F3 (ARR)

YES ERASE ARRAY NO

F1 F6

Press F1 (YES) to clear all programs from memory or F6 (NO) (or PRE) to abort this procedure without deleting anything. This operation clears any values assigned to matrices A, B, and C.

• To clear program memory

SHIFT CLR

McI Sci ARR PRG

F4

F4 (PRG)

YES ERASE ALL PROG NO

F1 F6

Press F1 (YES) to clear all programs from memory or F6 (NO) (or PRE) to abort this procedure without deleting anything.

■ Inputting Calculations

When you are ready to input a calculation, first press AC to clear the display. Next, input your calculation formulas exactly as they are written, from left to right, and press EXE to obtain a result.

Example 1 $2 + 3 - 4 + 10 =$

2 + 3 - 4 + 10 EXE

2+3-4+10 11.

Example 2 $2(5+4) \div (23 \times 5) =$

2 (5 + 4) ÷ (23 × 5) EXE

2(5+4) ÷ (23×5) 0.1565217391

The unit uses two types of functions: Type A functions and Type B functions. With Type A functions, you press the function key after you enter a value. With Type B functions, you press the function key first and then enter a value.

Example 1 (Type A function)

	Example	Key Operation
Squares:	4 ²	$\boxed{4} \boxed{x^2}$

Example 2 (Type B function)

	Example	Key Operation
Sine:	2 sin45°	$\boxed{2} \boxed{\sin} \boxed{4} \boxed{5}$

• For detailed examples on all of the possible calculations available, see the section titled "Calculation Priority Sequence" on page 61.

• To clear an entire calculation and start again

Press the **AC** key to clear the error along with the entire calculation. Next, re-input the calculation from the beginning.

■ Editing Calculations

Use the **◀** and **▶** keys to move the cursor to the position you want to change, and then perform one of the operations described below. After you edit the calculation, you can execute it by pressing **EXE**, or use **▶** to move to the end of the calculation and input more.

• To change a step

Example 1 To change 122 to 123

$\boxed{1} \boxed{2} \boxed{2}$ 122_

◀ 122

$\boxed{3}$ 123_

Example 2 To change cos60 to sin60

$\boxed{\cos} \boxed{6} \boxed{0}$ cos 60_

◀◀◀ cos 60

$\boxed{\sin}$ sin 60

• To delete a step

Example To change 369 × × 2 to 369 × 2

$\boxed{3} \boxed{6} \boxed{9} \boxed{\times} \boxed{\times} \boxed{2}$ 369xx2_

◀◀ DEL 369x2

• To insert a step

Example To change 2.36² to sin2.36²

$\boxed{2} \boxed{\cdot} \boxed{3} \boxed{6} \boxed{\text{SHIFT}} \boxed{x^2}$ 2.36²_

◀◀◀◀◀ 2.36²

$\boxed{\text{SHIFT}} \boxed{\text{INS}}$ 2.36²

$\boxed{\sin}$ sin 2.36²

• When you press **SHIFT INS** a space is indicated by the symbol "[]". The next function or value you input is inserted at the location of "[]". To abort the insert operation without inputting anything, move the cursor, press **SHIFT INS** again, or press **EXE**.

• To make corrections in the original calculation

Example $14 \div 0 \times 2.3$ entered by mistake for $14 \div 10 \times 2.3$

AC 1 4 ÷ 0 × 2 . 3 EXE

14÷0×2.3
Ma ERROR
Step 4

Press ◀ or ▶.

14÷0×2.3
|
Cursor is positioned automatically at the location of the cause of the error.

Make necessary changes.

◀ [SHIFT] [INS] 1

14÷10×2.3

Execute it again.

EXE

14÷10×2.3 3.22

■ Answer Function

The unit's Answer Function automatically stores the last result you calculated by pressing EXE (unless the EXE key operation results in an error). The result is stored in the answer memory.

• To recall the contents of the answer memory

Ans EXE

• To use the contents of the answer memory in a calculation

Example $123 + 456 = 579$
 $789 - 579 = 210$

AC 1 2 3 + 4 5 6 EXE

123+456 579.

7 8 9 - Ans

789-Ans_

EXE

789-Ans 210.

• The largest value that the answer memory can hold is one with 13 digits for the mantissa and 2 digits for the exponent.

• Answer memory contents are not cleared when you press the AC key or when you switch power off.

■ Using Multistatements

Multistatements are formed by connecting a number of individual statements for sequential execution. You can use multistatements in manual calculations and in programmed calculations. There are three different ways that you can use to connect statements to form multistatements.

• Colon (:)

Statements that are connected with colons are executed from left to right, without stopping.

• Display Result Command (▲)

When execution reaches the end of a statement followed by a display result command, execution stops and the result up to that point appears on the display. You can resume execution by pressing the EXE key.

• Newline Operation

The newline operation ends the line you are currently inputting, and moves the cursor to the next line. When execution reaches the end of a line where a newline operation was performed, the unit treats the end of the line like a colon (multistatement connector).

• To use multistatements

Example $6.9 \times 123 = 848.7$
 $123 \div 3.2 = 38.4375$

1 2 3 × ALPHA A SHIFT PRGM
F6 (:) 6 . 9 × ALPHA A
F5 (▲) ALPHA A ÷ 3 . 2

123→A:6.9×A▲
A÷3.2_

EXE

123→A:6.9×A▲
A÷3.2 848.7
- Disp -

Appears on display when "▲" is used.

EXE

123→A:6.9×A▲
A÷3.2 848.7
38.4375

• Note that the final result of a multistatement is always displayed, regardless of whether it ends with a display result command.

• You cannot construct a multistatement in which one statement directly uses the result of the previous statement.

Example $123 \times 456 \times 5$
Invalid

■ Multiplication Operations without a Multiplication Sign

You can omit the multiplication sign (\times) in any of the following operations.

- Before the type B functions (page 61) and coordinate transformation functions:

Example $2\sin 30$, $10\log 1.2$, $2\sqrt{3}$, $2\text{pol}(5, 12)$, etc.

- Before constants, variable names, value memory names

Example 2π , $2AB$, 3Ans , etc.

- Before an open parenthesis

Example $3(5+6)$, $(A+1)(B-1)$, etc.

■ Performing Continuous Calculations

The unit lets you use the result of one calculation as one of the arguments in the next calculation. The precision of such calculations is 10 digits (for the mantissa).

Example $3 \times 4 = 12$
 $12 \div 3.14 = 3.821656051$

AC 3 \times 4 EXE

3×4
12.

(Continuing) \div 3 . 1 4

12. ÷ 3. 14_

EXE

12. ÷ 3. 14
3. 821656051

Example $1 \div 3 \times 3 =$

AC 1 \div 3 \times 3 EXE

1÷3×3
1.

1 \div 3 EXE

1÷3
0. 3333333333

(Continuing) \times 3 EXE

0. 3333333333×3
0. 9999999999

Precision up to 10 digits

Continuous calculations can also be used with Type A functions (see page 61).

Example $78 \div 6 = 13$
 $13^2 = 169$

AC 7 8 \div 6 EXE

78÷6
13.

(Continuing) SHIFT x^2

13. x^2 _

EXE

13. x^2
169.

■ Using the Replay Function

The Replay Function automatically stores the last calculation performed in replay memory. You can recall the contents of the replay memory by pressing \leftarrow or \rightarrow . If you press \rightarrow , the calculation appears with the cursor at the beginning. Pressing \leftarrow causes the calculation to appear with the cursor at the end. You can make changes in the calculation as you wish and then execute it again.

Example To perform the following two calculations

$$4.12 \times 3.58 + 6.4 = 21.1496$$

$$4.12 \times 3.58 - 7.1 = 7.6496$$

AC 4 . 1 2 \times 3 . 5 8
 $+$ 6 . 4 EXE

4. 12×3. 58+6. 4
21. 1496

\leftarrow

4. 12×3. 58+6. 4_

$\leftarrow \leftarrow \leftarrow \leftarrow$

4. 12×3. 58+6. 4

$-$ 7 . 1

4. 12×3. 58-7. 1_

EXE

4. 12×3. 58-7. 1
7. 6496

- The maximum capacity of the replay memory is 127 steps.
- The contents of the replay memory are retained even if you press AC or switch power off.

Example

AC 1 2 3 X 4 5 6 EXE

123x456 56088.

AC

-

◀

123x456_

*The contents of the replay memory are cleared whenever you change from one menu to another.

Engineering Symbols

You can call up this menu to select engineering symbols for use in calculations.

To use engineering symbols in calculations

Example 1000 m × 5 k

1 0 0 0 SHIFT ENG SYM F1 (m) X
5 F6 (◁) F1 (k) EXE

1000m×5k 5000.

The following is a list of available engineering symbols and their meanings.

SHIFT ENG SYM displays:

F1 (m)	milli	10 ⁻³
F2 (μ)	micro	10 ⁻⁶
F3 (n)	nano	10 ⁻⁹
F4 (p)	pico	10 ⁻¹²
F5 (f)	femto	10 ⁻¹⁵
F6 (◁)	Next menu	

F6 displays:

F1 (k)	kilo	10 ³
F2 (M)	mega	10 ⁶
F3 (G)	giga	10 ⁹
F4 (T)	tera	10 ¹²
F5 (P)	peta	10 ¹⁵
F6 (E)	exa	10 ¹⁸

Scientific Functions

There are 4 scientific function menus: a Hyperbolic Function Menu, a Probability Function Menu, a Numeric Function Menu, and a Sexagesimal Function Menu.

To call up the Scientific Function Menu

SHIFT MATH

HYP PRB NUM DMS

To use the Hyperbolic Function Menu

SHIFT MATH

HYP PRB NUM DMS

F1

F1 (HYP)

snh csh tnh snh⁻¹ csh⁻¹ tnh⁻¹
F1 F2 F3 F4 F5 F6

Press the function key below the hyperbolic function you want to input.

- F1 (snh) hyperbolic sine
- F2 (csh) hyperbolic cosine
- F3 (tnh) hyperbolic tangent
- F4 (snh⁻¹) inverse hyperbolic sine
- F5 (csh⁻¹) inverse hyperbolic cosine
- F6 (tnh⁻¹) inverse hyperbolic tangent

Press PRB to backtrack to the Scientific Function Menu.

To use the Probability Function Menu

SHIFT MATH

HYP PRB NUM DMS

F2

F2 (PRB)

x! nPr nCr Rn#
F1 F2 F3 F4

Press the function key below the probability function you want to input.

- F1 (x!) factorial of x
- F2 (nPr) permutation
- F3 (nCr) combination
- F4 (Rn #) random number generation

Press PRB to backtrack to the Scientific Function Menu.

● To use the Numeric Function Menu

SHIFT MATH



F3 (NUM)



Press the function key below the numeric function you want to input.

- F1 (Abs) absolute value
- F2 (Int) integer extraction
- F3 (Frc) fraction extraction
- F4 (Rnd) rounding

Press PRE to backtrack to the Scientific Function Menu.

● To use the Sexagesimal Function Menu

SHIFT MATH



F4 (DMS)

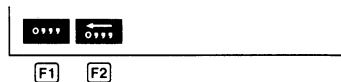

Press the function key below the sexagesimal function you want to input.

- F1 (0:00) For input of hours, minutes and seconds, or degrees, minutes and seconds as sexagesimal values
- F2 (0:00) For input of hours, minutes and seconds, or degrees, minutes and seconds as decimal values

Press PRE to backtrack to the Scientific Function Menu.

■ Value Memories

The unit comes with 28 value memories as standard (which can be expanded up to 548). You can use value memories to store values to be used inside of calculations. Value memories are identified by single-letter names, which are made up of the 26 letters of the alphabet, plus r and θ . The maximum size of values that you can assign to value memories is 13 digits for the mantissa and 2 digits for the exponent. Value memory contents are retained even when you switch power off.

Important

- Some value memories are used by the unit for certain types of calculations. Note the following.

Type of Calculation	Value Memories Used
Single-Variable Statistics (non-storage)	U, V, W
Paired-Variable Statistics (non-storage)	P, Q, R, U, V, W
Integration	K, L, M, N
Coordinate Conversion	I, J

You cannot assign values to these value memories while the above calculations are being performed. You should also clear the value memories before starting the above operations. Be especially careful during programmed calculations to avoid problems caused by values mistakenly assigned to memories that are used by the calculator.

● To assign a value to a value memory

Example To assign 123 to value memory A

1 2 3 → ALPHA A EXE

123→A
123.

Example To add 456 to value memory A and store the result in value memory B

ALPHA A + 4 5 6 → ALPHA B EXE

A+456→B
579.

● To store the result of an operation to a value memory

Example To store the result of log₂ to value memory S

log 2 → ALPHA S EXE

log₂→S
0.3010299957

● To display the contents of a value memory

Example To display the contents of value memory A



● To clear a value memory

Example To clear value memory A



● To clear all value memory contents



■ Increasing the Number of Value Memories

Though 28 value memories are provided as standard, you can configure the memory of the unit to increase the number of value memories and decrease the amount of program memory. Each additional value memory decreases the number of program memory steps by 8 (see page 174 for a full discussion of program steps).

Number of Value Memories	28	29	30	31	548
Number of Program Memory Steps	4164	4156	4148	4140	4

The maximum number of value memories possible is 548 (an increase of 520).

Important

- You may not be able to increase the number of value memories to the level you want if the memory already contains programs, matrices, function memory contents, or statistical data. If there is not enough unused memory available to increase to the number you specify, an error message will appear on the display.
- The **SHIFT** **Defm** specification can also be included within a program.

● To increase the number of value memories

Example To increase the number of value memories by 30 (for a total of 28 + 30 = 58)

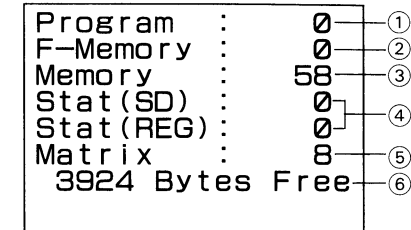

- ① Number of Program Steps Used
- ② Number of Function Memory Steps Used
- ③ Number of Value Memories Available
- ④ Number of Statistical Memory Steps Used
- ⑤ Number of Matrix Memory Steps Used
- ⑥ Number of Unused Program Steps Remaining

● To check the current memory status



● To initialize the number of value memories

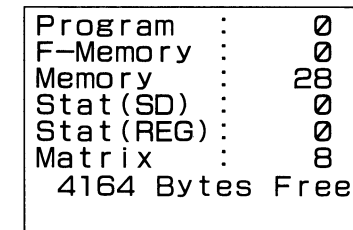
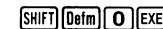

■ About memory names

You can use the additional memories you create from program memory just as you use the original 28. The names of the additional memories are Z[1], Z[2], Z[3], etc. If you increase the number of value memories by 5, you can access the original 28 memories, plus memories Z[1] through Z[5].

1-5 Using the BASE-N Mode

You can use the BASE-N Mode to perform calculations with binary, octal, decimal and hexadecimal values. You should also use this mode to convert between number systems and for logical operations.

- You cannot use scientific functions in the BASE-N Mode.
- You can use only integers in the BASE-N Mode, so fractional values are not allowed. If you input a value that includes a decimal part, the unit automatically cuts off the decimal.
- If you attempt to enter a value that is invalid in the number system (binary, octal, decimal, hexadecimal) you are using, the calculator displays an error message. The following show the numerals that can be used in each number system.

Binary: 0, 1

Octal: 0, 1, 2, 3, 4, 5, 6, 7

Decimal: 0, 1, 2, 3, 4, 5, 6, 7, 8, 9

Hexadecimal: 0, 1, 2, 3, 4, 5, 6, 7, 8, 9, A, B, C, D, E, F

- The alphabetic characters used in the hexadecimal number appear differently on the display to distinguish them from text characters.

Normal Text: A, B, C, D, E, F

Hexadecimal Values: **A**, **B**, **C**, **D**, **E**, **F**

- Negative binary, octal, and hexadecimal values are produced using the two's complement of the original value.

- The following are the display capacities for each of the number systems.

Number System	Display Capacity
Binary	16 digits
Octal	11 digits
Decimal	10 digits
Hexadecimal	8 digits

- The following are the calculation capacities for each of the number systems.

Calculation Ranges in BASE-N Mode

Binary Values

Negative : $1000000000000000 \leq x \leq 1111111111111111$

Positive : $0 \leq x \leq 1111111111111111$

Octal Values

Negative : $200000000000 \leq x \leq 3777777777$

Positive : $0 \leq x \leq 1777777777$

Decimal Values

Negative : $-2147483648 \leq x \leq -1$

Positive : $0 \leq x \leq 2147483647$

Hexadecimal Values

Negative : $80000000 \leq x \leq FFFFFFFF$

Positive : $0 \leq x \leq 7FFFFFFF$

- To enter the BASE-N Mode

MODE 

Main BASE-N Mode screen

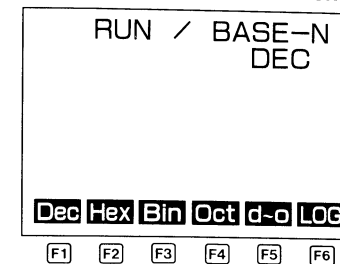

- To set the default BASE-N Mode number system

Example To set the default BASE-N Mode number system to decimal

F1(Dec) EXE



The following are the number systems that are available.

F1(Dec) decimal

F2(Hex) hexadecimal

F3(Bin) binary

F4(Oct) octal

- To convert a displayed value from one number system to another

Example To convert 1,038₁₀ (default number system) to its hexadecimal value

1 0 3 8 EXE

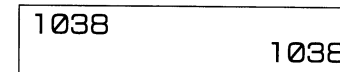

F2(Hex) EXE

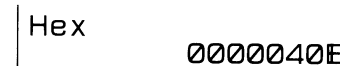

● To input values of mixed number systems

Example To input $1,038_D + 25C_H + 11011_B + 23_O$, when the default number system is decimal

F1(Dec) EXE
 1 0 3 8 + F5(d~o) F2(h)
 2 5 C + F3(b) 1 1 0 1 1
 + F4(o) 2 3 EXE

Dec

1038+h25C+b11011
+o23

1688

d h b o

F1 F2 F3 F4

The following are the types of values that can be specified in the above menu.

- F1(d) decimal value
- F2(h) hexadecimal value
- F3(b) binary value
- F4(o) octal value

Press PRE to backtrack to the main BASE-N Mode screen.

● To input logical operations

Example To input and execute “120₁₆ and AD₁₆”

MODE
 F2(Hex) EXE
 1 2 0 F6(LOG) F3(and) A
 D EXE

Hex

120andAD

00000000
00000020

Neg Not and or xor xnor

F1 F2 F3 F4 F5 F6

The following are the logical operations that can be input from the above menu.

- F1(Neg) negation
- F2(Not) NOT
- F3(and) AND
- F4(or) OR
- F5(xor) XOR
- F6(xnor) XNOR

Press PRE to backtrack to the main BASE-N Mode screen.

1-6 Using the Matrix Mode

■ About Matrices

This unit's matrix operations use 3 matrices, named A, B, C. The following table shows how each matrix is used.

Matrix Name	A	B	C
Addition/Subtraction/ Multiplication/Division	○	○	Result
Scalar Product	○	○	Result
Transposition Matrix	○	○	Result
Determinant	○	○	Not used
Inverse Matrix	○	○	Result
Matrix Exchange	Exchange of A and B		Not used
Matrix C Copy	Destination		Origin
Matrix Dimension	9×9 maximum		

● To enter the Matrix Mode

MODE 0

Main Matrix Mode screen

RUN / MATRIX

A(2×2) B(2×2)

C(0×0)

angle : Deg

display: Nrm1

A B + - x C

F1 F2 F3 F4 F5 F6

Matrix Mode Title
 Matrix Sizes
 Unit of Angular Measurement
 Display Format

The following are the operations that are available from this menu. Press the function key below the operation you want to perform.

- F1(A) Displays matrix A contents
- F2(B) Displays matrix B contents
- F3(+) Adds matrix A and matrix B
- F4(-) Subtracts matrix B from matrix A
- F5(×) Multiplies matrix A and matrix B
- F6(C) Displays matrix C contents

Important

Many of the matrix operations described in this manual are performed using matrix A in examples. Note that the same operations can be used with matrix B.

● To clear matrix memory

SHIFT CLR F3 (ARR)



Press F1 (YES) to clear matrix memory or F6 (NO) (or PRE) to abort the operation without clearing anything.

You should clear matrix memory if you want to perform any non-matrix calculations that use memories. Note that the above operation is not required if you have specified a new matrix size, because the size specification automatically clears matrix memory.

● To specify matrix size

Example To specify a size of 3 × 3 for matrix A

F1 (A)



F6 (▽)



F1 (DIM)

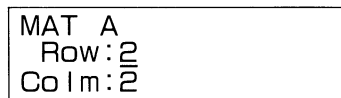

3 EXE 3

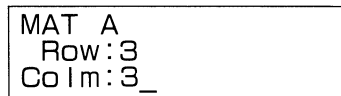

EXE

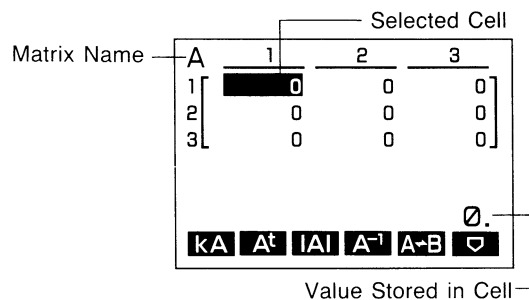

● To input matrix data

Example To input the following data into matrix A (3 × 4)

$$\begin{pmatrix} 1 & 0 & 3 & 4 \\ 2 & 1 & 0 & 1 \\ 3 & 1 & -2 & -3 \end{pmatrix}$$

Input each value and press EXE.

1 EXE 0 EXE 3 EXE 4 EXE
 2 EXE 1 EXE 0 EXE 1 EXE
 3 EXE 1 EXE - 2 EXE - 3 EXE

• After you finish inputting the data, you can return to the main Matrix Mode display by pressing PRE.

● To move around a matrix

You can move around the matrix using the cursor keys.

- ▲ Moves up.
- ▼ Moves down.
- ◀ Moves left.
- ▶ Moves right.

If the pointer is at the far left of a row and there is another row above, pressing this key scrolls to the line above, with the pointer at the far right of the line.

▶ Moves right.

If the pointer is at the far right of a row and there is another row below, pressing this key scrolls to the line below, with the pointer at the far left of the line.

• Holding down any of the cursor keys performs the corresponding operation at high speed.

● Capacity of each cell

- Only 5 rows and 3 columns of a matrix can be shown on the display. The cursor key operations cause the screen to scroll in order to accommodate larger matrices.
- The capacity for each cell is 6 digits for positive values and 5 digits for negative values.
- Exponential values are cut off to one significant digit.

■ Performing Matrix Arithmetic Operations

You can use matrix A and matrix B contents in addition, subtraction and multiplication operations. The examples of these operations presented here are based on the following 2 matrices.

Matrix A	Matrix B
$\begin{pmatrix} 1 & 1 \\ 2 & 1 \end{pmatrix}$	$\begin{pmatrix} 2 & 3 \\ 2 & 1 \end{pmatrix}$

Create these matrices in memory using the following procedure.

• To input matrix A data

MODE 0 F1(A) F6(□) F1(DIM)
 2 EXE 2 EXE
 1 EXE 1 EXE
 2 EXE 1 EXE

A	1	2
1 [█	1
2 [2	1

• To input matrix B data

PRE F2(B) F6(□) F1(DIM)
 2 EXE 2 EXE
 2 EXE 3 EXE
 2 EXE 1 EXE

B	1	2
1 [█	3
2 [2	1

• To add matrix A and matrix B

PRE

A	B	+	-	×	C
---	---	---	---	---	---

F3

F3(+)

C	1	2
1 [█	4
2 [4	2

3.

C→A	C→B	ERS
-----	-----	-----

F1 F2 F3

• Matrix C appears, showing the sum of the values in the cells of matrix A and matrix B.

• The following are the operations that are available from the function display at the bottom of the screen. Press the function key below the operation you want to perform.

- F1(C→A) Transfers matrix C contents to matrix A (deleting matrix A contents)
- F2(C→B) Transfers matrix C contents to matrix B (deleting matrix B contents)
- F3(ERS) Deletes the matrix

Important

• Matrix A and matrix B can be added only if the dimensions of the matrices are identical. Different dimensions produce a "Dim ERROR" when you try to add the matrices.

• To subtract matrix B from matrix A

PRE

A	B	+	-	×	C
---	---	---	---	---	---

F4

F4(-)

C	1	2
1 [█	-2
2 [0	0

-1.

C→A	C→B	ERS
-----	-----	-----

F1 F2 F3

• Matrix C appears, showing the difference of the values in the cells of matrix A and matrix B.

• The following are the operations that are available from the function display at the bottom of the screen. Press the function key below the operation you want to perform.

- F1(C→A) Transfers matrix C contents to matrix A (deleting matrix A contents)
- F2(C→B) Transfers matrix C contents to matrix B (deleting matrix B contents)
- F3(ERS) Deletes the matrix

Important

• Matrix A and matrix B can be subtracted only if the dimensions of the matrices are identical. Different dimensions produce a "Dim ERROR" when you try to subtract the matrices.

• You cannot subtract matrix A from matrix B. To accomplish the equivalent result though, you can exchange the contents of matrix A and matrix B (see page 56) and then perform the subtraction operation.

• To multiply matrix A by matrix B

PRE



F5(×)

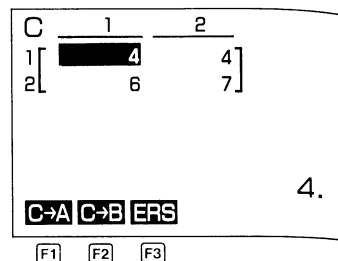

- Matrix C appears, showing the product of the values in the cells of matrix A and matrix B.
- The following are the operations that are available from the function display at the bottom of the screen. Press the function key below the operation you want to perform.
 - F1(C→A) Transfers matrix C contents to matrix A (deleting matrix A contents)
 - F2(C→B) Transfers matrix C contents to matrix B (deleting matrix B contents)
 - F3(ERS) Deletes the matrix

Important

- Matrix A and matrix B can be multiplied only if they are of identical size (but not necessarily of identical dimensions). If matrix A is 3×2 , for example, it can be used for multiplication with a matrix B that is $2 \times n$ ($n = 1 \sim 9$). Different sizes produce a “Dim ERROR” when you try to multiply the matrices.
- You cannot multiply matrix B by matrix A. To accomplish the equivalent result though, you can exchange the contents of matrix A and matrix B (see page 56) and then perform the multiplication operation.

■ Other Matrix Operations

A Matrix Function Menu provides calculation of the scalar product, transposition, calculation of the determinant, and calculation of the inverse matrix. A Matrix Editing Menu lets you make changes to the configuration of a matrix after you already have it set up.

• To display the Matrix Function Menu

Example To display the Matrix Function Menu for matrix A

F1(A)



- The following are the operations that are available from the function display at the bottom of the screen. Press the function key below the operation you want to perform.
 - F1(kA) Returns the scalar product of matrix A
 - F2(A^t) Transposes matrix A
 - F3(|A|) Returns the determinant of matrix A
 - F4(A⁻¹) Returns the inverse matrix for matrix A
 - F5(A↔B) Exchanges the contents of matrix A and matrix B
 - F6(▽) Matrix Editing Menu

Important

- Performing the above operations on the contents of matrix A stores the results in matrix C.

• To display the Matrix Editing Menu

Example To display the Matrix Editing Menu for matrix A

F6(▽)



- The following are the operations that are available from the function display at the bottom of the screen. Press the function key below the operation you want to perform.
 - F1(DIM) For specification of the size of the matrix
 - F2(ERS) Deletes the matrix
 - F3(CLR) Clears the matrix
 - F4(ROW) Adds, inserts, and deletes rows
 - F5(COL) Adds, inserts, and deletes columns

● To delete a matrix

Example To delete matrix A

F1(A)

F6(∇)

F2(ERS)

YES ERASE MAT A **NO**
F1 **F6**

Press **F1** (YES) to delete the matrix or **F6** (NO) (or **PRE**) to abort the operation without clearing anything. When the matrix is deleted, the following message appears to indicate that the matrix no longer exists.

A
 No existence
DIM ERS CLR ROW COL

• At this point, both the row and column dimensions for the matrix become zero.

F1(Dim)

MAT A
 Row: 0
 Colm: 0

To perform another matrix calculation, be sure to set the dimensions of the matrix first.

● To clear the contents of a matrix

Example To clear matrix A

F1(A)

F6(∇)

F3(CLR)

A	1	2
1	0	0
2	0	0

0.
kA A^t |A| A⁻¹ A-B ∇

All of the cells of the matrix are cleared to zeros.

● To delete a row from a matrix

Example To delete row 2 from matrix A

F1(A)

F6(∇)

F4(ROW)

∇

DEL INS ADD <ROW>
F1 F2 F3

A	1	2	3
1	1	2	3
2	4	5	6
3	7	8	9

4.
DEL INS ADD <ROW>
F1

F1(DEL)

A	1	2	3
1	1	2	3
2	7	8	9

The selected row is deleted.

● To insert a row in a matrix

Example To insert a row between row 1 and row 2 of matrix A

F1(A)

F6(∇)

F4(ROW)

∇

A	1	2
1	1	2
2	1	2
3	1	1
4	1	1

1.
DEL INS ADD <ROW>
F2

F2 (INS)

A	1	2
1	1	2
2	0	0
3	1	2
4	1	1
5	1	1

DEL INS ADD <ROW> 0.

The row is inserted above the selected row.

● To add a row to a matrix

Example To add a row following row 4 of matrix A

F1 (A)

F6 (▽)

F4 (ROW)

▽▽▽

A	1	2
1	1	2
2	3	4
3	5	6
4	7	8

DEL INS ADD <ROW> 7.

F3

F3 (ADD)

A	1	2
1	1	2
2	3	4
3	5	6
4	7	8
5	0	0

DEL INS ADD <ROW> 0.

The row is added after the selected row.

● To delete a column from a matrix

Example To delete column 2 from matrix A

F1 (A)

F6 (▽)

F5 (COL)

▶

A	1	2	3
1	1	2	3
2	4	5	6
3	7	8	9

DEL INS ADD <COLUMN> 2.

F1 F2 F3

A	1	2	3
1	1	2	3
2	4	5	6
3	7	8	9

DEL INS ADD <COLUMN> 2.

F1

F1 (DEL)

A	1	2
1	1	3
2	4	6
3	7	9

The selected column is deleted.

● To insert a column in a matrix

Example To insert a column between columns 1 and 2 of matrix A

F1 (A)

F6 (▽)

F5 (COL)

▶

A	1	2
1	1	2
2	1	2
3	1	1
4	1	1

DEL INS ADD <COLUMN> 2.

F2

F2 (INS)

A	1	2	3
1	1	0	2
2	1	0	2
3	1	0	1
4	1	0	1

0.
DEL INS ADD < COLUMN >

The column is inserted to the left of the selected column.

• To add a column to a matrix

Example To add a column between columns 1 and 2 of matrix A

F1 (A)

F6 (▽)

F5 (COL)

A	1	2
1	1	2
2	3	4
3	5	6
4	7	8

1.
DEL INS ADD < COLUMN >

F3

F3 (ADD)

A	1	2	3
1	1	0	2
2	3	0	4
3	5	0	6
4	7	0	8

0.
DEL INS ADD < COLUMN >

The column is added to the right of the selected column.

• To calculate the scalar product

Example To calculate a scalar product by multiplying the following data in Matrix A by 4

Matrix A

$$\begin{pmatrix} 1 & 2 \\ 3 & 4 \end{pmatrix}$$

F1 (A)

A	1	2
1	4	8
2	12	16

1.
kA A^t |A| A⁻¹ A-B ▽

F1

4 F1 (kA)

C	1	2
1	4	8
2	12	16

- The entered value must be a real number.
- Results are stored in matrix C.

• To transpose a matrix

Example To transpose the following data in matrix A

Matrix A

$$\begin{pmatrix} 1 & 2 \\ 3 & 4 \\ 5 & 6 \end{pmatrix}$$

F1 (A)

A	1	2
1	1	2
2	3	4
3	5	6

1.
kA A^t |A| A⁻¹ A-B ▽

F2

F2(A')

C	1	2	3
1	1	3	5
2	2	4	6

1.

C→A C→B ERS

• This operation transposes matrix A (changing the columns to rows and rows to columns) and stores the results in matrix C.

• To calculate the determinant

Example To calculate the determinant of the following data

Matrix A

$$\begin{pmatrix} 1 & 2 & 3 \\ 4 & 5 & 6 \\ -1 & -2 & 0 \end{pmatrix}$$

F1(A)

A	1	2	3
1	1	2	3
2	4	5	6
3	-1	-2	0

1.

kA A^t |A| A⁻¹ A-B

F3

F3(|A|)

det A = -9.

- This operation calculates the determinant of square matrix A or B.
 - Note that the determinant can be calculated for square matrices (same number of rows and columns) only. A "Dim ERROR" occurs when this operation is attempted with a matrix that is not a square matrix.
 - The number of steps required to perform this operation can be determined by the following formula:
(number of rows × number of columns) × 8
- A Mem ERROR occurs if there is not enough memory to perform the operation.

• To calculate an inverse matrix

Example To calculate the inverse matrix of the following data

Matrix A

$$\begin{pmatrix} 1 & 2 \\ 3 & 4 \end{pmatrix}$$

F1(A)

A	1	2
1	1	2
2	3	4

1.

kA A^t |A| A⁻¹ A-B

F4

F4(A⁻¹)

C	1	2
1	-2	1
2	1.5	-0.5

-2.

C→A C→B ERS

- This operation calculates the inverse of square matrix A or B and stores the results in matrix C.
- The dimension of matrix C is the same as matrix A or B.
- There is no inverse matrix when $ad - bc = 0$ (when the matrix equals 0). In such a case, the above operation produces a "Ma ERROR".
- Note that the inverse matrix can be calculated for square matrices (same number of rows and columns) only. A "Dim ERROR" occurs when this operation is attempted with a matrix that is not a square matrix.
- Matrix A^{-1} (which is the inverse of matrix A) satisfies the following conditions.

$$AA^{-1} = E = \begin{pmatrix} 1 & 0 \\ 0 & 1 \end{pmatrix}$$

- The following is applied to the inverse matrix (A^{-1}) of 2×2 square matrix A.

$$A = \begin{pmatrix} a & b \\ c & d \end{pmatrix}$$

Therefore, $A^{-1} = \frac{1}{ad - bc} \begin{pmatrix} d & -b \\ -c & a \end{pmatrix}$ when $ad - bc \neq 0$

• To exchange matrix A and matrix B contents

Example To exchange the contents of matrix A and matrix B when they originally contain the following data

Matrix A	Matrix B
$\begin{pmatrix} 1 & 2 \\ 3 & 4 \end{pmatrix}$	$\begin{pmatrix} -1 & 2 \\ 3 & 4 \end{pmatrix}$

F1(A)

	1	2	
1	1	2	
2	3	4	

1.
kA A^t |A| A⁻¹ A-B ▾

F5

F5(A→B)

	1	2	
1	-1	2	
2	3	4	

• This operation exchanges the contents of matrix A and matrix B.

1-7 Using the Function Memory

You can store up to six functions in memory for instant recall when you need them. Function memory can be used in any mode except the BASE-N Mode.

• To display the Function Memory Menu

SHIFT **F1MEM**

STO RCL fn LIST

F1 **F2** **F3** **F4**

• The following are the operations that are available from the function display at the bottom of the screen. Press the function key below the operation you want to perform.

- F1**(STO) Stores functions
- F2**(RCL) Recalls functions
- F3**(fn) Specifies input as a function. See page 162 for an example of **F3**(fn) operation.
- F4**(LIST) Displays a list of stored functions

• To store a function

Example To store the function $(A + B)(A - B)$ as function memory number 3.

(**ALPHA** **A** **+** **ALPHA** **B** **)** **(** **ALPHA** **A** **-** **ALPHA** **B** **)** **SHIFT** **F1MEM**

$(A+B)(A-B)$ _

STO RCL fn LIST

F1

F1(STO)

STO RCL fn LIST

3

FUNCTION MEMORY

f 1 :
 f 2 :
 f 3 : (A+B)(A-B)
 f 4 :
 f 5 :
 f 6 :

STO RCL fn LIST

• If the function memory number you assign a function to already contains a function, the previous function is replaced with the new one.

• To recall a function

Example To recall function memory number 3

SHIFT [F]MEM

STO RCL fn LIST

F2

F2(RCL)

STO RCL fn LIST

3

(A+B) (A-B) _

•The recalled function appears at the current location of the cursor on the display.

• To display a list of available functions

SHIFT [F]MEM

STO RCL fn LIST

F4

F4(LIST)

FUNCTION MEMORY

f 1 :
f 2 :
f 3 : (A+B) (A-B)
f 4 :
f 5 :
f 6 :
STO RCL fn LIST

• To delete a function

Example To delete function memory number 3

SHIFT [F]MEM

STO RCL fn LIST

F1

AC

F1(STO)

STO RCL fn LIST

3

FUNCTION MEMORY

f 1 :
f 2 :
f 3 :
f 4 :
f 5 :
f 6 :
STO RCL fn LIST

•Executing the store operation while the display is blank deletes the function for the Function Memory you specify.

1-8 Graphic and Text Displays

The unit uses both a graphic display and a text display. The graphic display is used for graphics, while the text display is used for calculations and instructions. The contents of each type of display are stored in independent memory areas.

● To switch between the graphic display and text display

Press the [D-T] key. You should also note that the key operations used to clear each type of display are different.

● To clear the graphic display

Press $\text{[SHIFT][F5]}(\text{Cls})\text{[EXE]}$.

● To clear the text display

Press [AC] .

If you press [AC] while in the graphic display, the calculator clears the display and automatically switches to the text display. Though the graphic display is cleared, it remains in memory, so you can return the graph to the display by pressing [D-T] .

1-9 Technical Information

This section provides information on the internal workings of the unit.

■ Calculation Priority Sequence

This calculator employs true algebraic logic to calculate the parts of a formula in the following order:

- ① Coordinate transformation/integration
Pol (x, y) , Rec (r, θ) , $\int dx$
- ② Type A functions
With these functions, the value is entered and then the function key is pressed.
 x^2 , x^{-1} , $x!$, 0° , ENG symbols
- ③ Power/root
 x^r , $\sqrt{\quad}$
- ④ Fractions
 $a^{b/c}$
- ⑤ Abbreviated multiplication format in front of π , memory or parenthesis
 2π , $4\text{IK}1$, $5A$, πR , etc.
- ⑥ Type B functions
With these functions, the function key is pressed and then the value is entered.
 $\sqrt{\quad}$, $\sqrt[3]{\quad}$, \log , \ln , e^x , 10^x , \sin , \cos , \tan , \sin^{-1} , \cos^{-1} , \tan^{-1} , \sinh , \cosh , \tanh , \sinh^{-1} , \cosh^{-1} , \tanh^{-1} , $(-)$, parenthesis, (following in BASE-N calculations only) d , h , b , o , Neg, Not
- ⑦ Abbreviated multiplication format in front of Type B functions
 $2\sqrt{3}$, $A \log 2$, etc.
- ⑧ Permutation, combination
 nPr , nCr
- ⑨ \times , \div
- ⑩ $+$, $-$
- ⑪ and
- ⑫ or, xor, xnor] BASE-N calculations only

*When functions with the same priority are used in series, execution is performed from right to left.

$$e^{\ln\sqrt{120}} \rightarrow e^{\{\ln(\sqrt{120})\}}$$

Otherwise, execution is from left to right.

*Anything contained within parentheses receives highest priority.

Example $2 + 3 \times (\log \sin 2\pi^2 + 6.8) = 22.07101691$ (in the "Rad" mode)

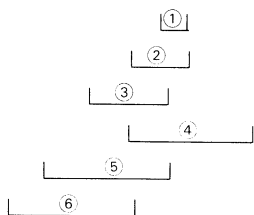

Stacks

The unit employs memory blocks, called *stacks*, for storage of low priority values and commands. There is a 10-level *numeric value stack*, a 26-level *command stack*, and a 10-level *program subroutine stack*. If you execute a formula that is so complex it exceeds the amount of stack space available, a stack error (Stk ERROR) message appears on the display.

Stk ERROR
Step 26

Example $2 \times ((3 + 4 \times (5 + 4) \div 3) \div 5) + 8 =$

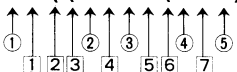

Numeric Value Stack

①	2
②	3
③	4
④	5
⑤	4
⋮	

Command Stack

①	×
②	(
③	(
④	+
⑤	×
⑥	(
⑦	+
⋮	

- Calculations are performed according to the priority sequence described on page 61. Once a calculation is executed, it is cleared from the stack.

Value Input and Output Limitations

The allowable range for both input and output values is 10 digits for the mantissa and 2 digits for the exponent. Internally, however, the unit performs calculations using 13 digits for the mantissa and 2 digits for the exponent.

Example $3 \times 10^5 \div 7 =$

3 EXP 5 \div 7 EXE

3 EXP 5 \div 7 = 4 2 8 5 7
EXE

3E5 \div 7
42857.14286
3E5 \div 7-42857
0.14285714

- Calculation results that are greater than 10^{10} (10 billion) or less than 10^{-2} (0.01) are automatically displayed in exponential form.

Example $3 \times 10^5 \div 7 =$

3 EXP 5 \div 7 EXE

= 4 2 8 5 7 EXE

3E5 \div 7
42857.14286
42857.14286-42857
7
0.14286

After a calculation is complete, the calculator rounds off the mantissa to 10 digits and displays the result. The displayed result can be used in the next calculation.

- Values are stored in memory with 13 digits for the mantissa and 2 digits for the exponent.

Steps

The unit has a 127-step area for execution of calculations. Each time you press a numeric key or an arithmetic operation key, one step of memory is used. Each function in your calculation also takes up one step. Though such operations as $\text{SHIFT} \text{ } \text{X}^2$ require two key operations, they take up only one step, because the two key operations actually input a single function.

You can count steps using the cursor. Each time you press \leftarrow or \rightarrow , the cursor moves one step.

A calculation can consist of up to 127 steps. Whenever you input the 122nd step of any calculation, the cursor changes from "—" to "■" on the display, to let you know that you are running out of memory. If you still need to input more, you should divide your calculation into two or more parts.

Note)

*As you input numeric values or commands, they appear flush left on the display. Calculation results, on the other hand, are displayed flush right.

■ Overflow and Errors

Exceeding a specified input or calculation range, or attempting an illegal input causes an error message to appear on the display. Further operation of the calculator is impossible while an error message is displayed. The following events cause an error message to appear on the display.

- When any result, whether intermediate or final, or any value in memory exceeds $\pm 9.99999999 \times 10^{99}$ (Ma ERROR)
- When an attempt is made to perform a function calculation that exceeds the input range (Ma ERROR) (see page 207)
- When an illegal operation is attempted during statistical calculations (Ma ERROR)
For example, attempting to obtain \bar{x} or $x\sigma n$ without data input.
- When the capacity of the numeric value stack or command stack is exceeded (Stk ERROR)
For example, entering 23 successive \square , followed by $2 \div 3 \times 4$.
- When an attempt is made to perform a calculation using an illegal formula (Syn ERROR)
For example, $5 \times \square \times 3 \text{EXE}$.
- When an illegal memory specification is made (Mem ERROR)
- When an illegal command or function argument is used (Arg ERROR)
- When an attempt is made to use an illegal dimension during matrix calculations (Dim ERROR)

Notes

- * Other errors can occur during program execution. See page 205 for details.
- Most of the calculator's keys are inoperative while an error message is displayed. You can resume operation using one of the two following procedures.
- * Press the **AC** key to clear the error and return to normal operation.
- * Press \leftarrow or \rightarrow to display the error (see page 28).

■ Exponential Display

During normal calculation, the unit is capable of displaying up to 10 digits. Values that exceed this limit, however, are automatically displayed in exponential format. You can choose between 2 different types of exponential display formats.

Norm 1: $10^{-2}(0.01) > |x|, |x| \geq 10^{10}$

Norm 2: $10^{-9}(0.000000001) > |x|, |x| \geq 10^{10}$

You can select between Norm 1 and Norm 2 using the Display Mode (page 20). Pressing **Disp** displays the current mode settings.

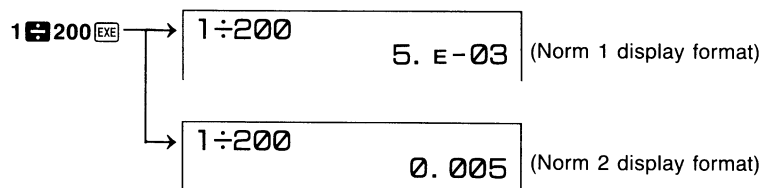

(All of the examples in this manual show calculation results using Norm 1.)

How to interpret exponential format

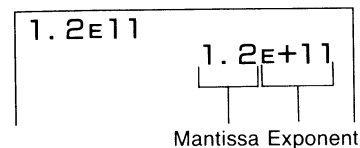

$$\rightarrow 1.2 \times 10^{11} \rightarrow 120,000,000,000$$

$1.2\text{E}+11$ indicates that the result is equivalent to 1.2×10^{11} . This means that you should move the decimal point in 1.2 eleven places to the right, since the exponent is positive. This results in the value 120,000,000,000.

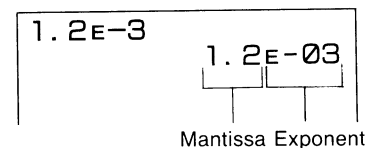

$$\rightarrow 1.2 \times 10^{-3} \rightarrow 0.0012$$

$1.2\text{E}-03$ indicates that the result is equivalent to 1.2×10^{-3} . This means that you should move the decimal point in 1.2 three places to the left, since the exponent is negative. This results in the value 0.0012.

Chapter

2

Manual Calculations

- 2-1 Arithmetic Calculations
- 2-2 Units of Angular Measurement
- 2-3 Trigonometric and Inverse Trigonometric Functions
- 2-4 Logarithmic and Exponential Functions
- 2-5 Hyperbolic and Inverse Hyperbolic Functions
- 2-6 Other Functions
- 2-7 Coordinate Conversion
- 2-8 Permutation and Combination
- 2-9 Fractions
- 2-10 Engineering Symbol Calculations
- 2-11 Number of Decimal Places, Number of Significant Digits, Display Format
- 2-12 Calculations Using Memory
- 2-13 BASE-N Mode Calculations

Manual calculations are those that you input manually, as on the simplest of calculators. They are to be distinguished from programmed calculations. This chapter provides a various examples to help you become familiar with the manual calculation capabilities of the unit.

2-1 Arithmetic Calculations

- Enter arithmetic calculations as they are written, from left to right.
- Use the **SHIFT** **(-)** key to input the minus sign before a negative value.
- Calculations are performed internally with a 13-digit mantissa. The display is rounded to a 10-digit mantissa before it is displayed.

Example	Operation	Display
$23 + 4.5 - 53 = -25.5$	23 + 4.5 = 53 EXE	- 25.5
$56 \times (-12) \div (-2.5) = 268.8$	56 x SHIFT (-) 12 = SHIFT (-) 2.5 EXE	268.8
$12369 \times 7532 \times 74103 = 6.903680613 \times 10^{12}$ (6903680613000)	12369 x 7532 x 74103 EXE	6.903680613E+12
$(4.5 \times 10^{75}) \times (-2.3 \times 10^{-79}) = -1.035 \times 10^3$ (-0.001035)	4.5 EXP 75 x SHIFT (-) 2.3 EXP SHIFT (-) 79 EXE	- 1.035E-03 (Norm 1 display format)
$(2 + 3) \times 10^2 = 500$ * 2 + 3 = EXP 2 does not produce the correct result. Be sure to enter this calculation as shown.	(2 + 3) x 1 EXP 2 EXE	500.
$(1 \times 10^5) \div 7 = 14285.71429$	1 EXP 5 = 7 EXE	14285.71429
$(1 \times 10^5) \div 7 - 14285 = 0.71428571$	1 EXP 5 = 7 = 14285 EXE	0.71428571

- For mixed arithmetic calculations, multiplication and division are given priority over addition and subtraction.

Example	Operation	Display
$3 + 5 \times 6 = 33$	3 + 5 x 6 EXE	33.
$7 \times 8 - 4 \times 5 = 36$	7 x 8 = 4 x 5 EXE	36.
$1 + 2 - 3 \times 4 \div 5 + 6 = 6.6$	1 + 2 = 3 x 4 = 5 + 6 EXE	6.6

Calculations Using Parentheses

Example	Operation	Display
$100 - (2 + 3) \times 4 = 80$	100 = (2 + 3) x 4 EXE	80.
$2 + 3 \times (4 + 5) = 29$ *The final closed parentheses (immediately before operation of the EXE key) may be omitted, no matter how many are required.	2 + 3 x (4 + 5) EXE	29.
$(7 - 2) \times (8 + 5) = 65$ *A multiplication sign immediately before an open parenthesis may be omitted.	(7 = 2) (8 + 5) EXE	65.
$10 - \{2 + 7 \times (3 + 6)\} = -55$ *In this manual, the multiplication sign is always shown.	10 = (2 + 7 (3 + 6)) EXE	- 55.
$\frac{2 \times 3 + 4}{5} = (2 \times 3 + 4) \div 5 = 2$	(2 x 3 + 4) = 5 EXE	2.
$\frac{5 \times 6 + 6 \times 8}{15 \times 4 + 12 \times 3} = 0.8125$	(5 x 6 + 6 x 8) = (15 x 4 + 12 x 3) EXE	0.8125
$(1.2 \times 10^{19}) - \{(2.5 \times 10^{20}) \times \frac{3}{100}\} = 4.5 \times 10^{18}$	1.2 EXP 19 = (2.5 EXP 20 x 3 = 100) EXE	4.5E+18
$\frac{6}{4 \times 5} = 0.3$ *The above is identical to 6 = 4 x 5 EXE	6 = (4 x 5) EXE	0.3

2-2 Units of Angular Measurement

- See page 20 for full details on specifying the unit of angular measurement.
- Once you specify a unit of angular measurement, it remains in effect until you specify a different one. The specification is retained even if you switch power off.

Example	Operation	Display
Result displayed in degrees. To convert 4.25 rad to degrees.	$\text{SHIFT} \text{DRG} \text{F1} (\text{Deg}) \text{EXE}$ $4.25 \text{FS} (r) \text{EXE}$	243.5070629
$47.3^\circ + 82.5\text{rad} = 4774.20181$	$47.3 \text{+} 82.5 \text{FS} (r) \text{EXE}$	4774.20181

2-3 Trigonometric and Inverse Trigonometric Functions

- Be sure to set the unit of angular measurement before performing trigonometric function and inverse trigonometric function calculations.
- The following calculations cannot be performed in the BASE-N Mode.

Example	Operation	Display
$\sin 63^\circ 52' 41'' = 0.897859012$	$\text{SHIFT} \text{DRG} \text{F1} (\text{Deg}) \text{EXE}$ $\text{sin} \text{63} \text{SHIFT} \text{MATH} \text{F4} (\text{DMS})$ $\text{F1} (o', ' ') \text{52} \text{F1} (o', ' ') \text{41}$ $\text{F1} (o', ' ') \text{EXE}$	0.897859012
$\cos\left(\frac{\pi}{3} \text{rad}\right) = 0.5$	$\text{SHIFT} \text{DRG} \text{F2} (\text{Rad}) \text{EXE}$ $\text{cos} \text{[]} \text{SHIFT} \text{[]} \text{[]} \text{3} \text{[]} \text{EXE}$	0.5
$\tan(-35\text{gra}) = -0.6128007881$	$\text{SHIFT} \text{DRG} \text{F3} (\text{Gra}) \text{EXE}$ $\text{tan} \text{SHIFT} \text{[]} \text{35} \text{EXE}$	-0.6128007881
$2 \cdot \sin 45^\circ \times \cos 65^\circ$ $= 0.5976724775$	$\text{SHIFT} \text{DRG} \text{F1} (\text{Deg}) \text{EXE}$ $2 \text{X} \text{sin} \text{45} \text{X} \text{cos} \text{65} \text{EXE}$ $\uparrow \quad \quad \uparrow$ Can be omitted.	0.5976724775
$\cot 30^\circ = \frac{1}{\tan 30^\circ}$ $= 1.732050808$	$1 \text{[]} \text{tan} \text{30} \text{EXE}$	1.732050808

2-4 Logarithmic and Exponential Functions

•The following calculations cannot be performed in the BASE-N Mode.

Example	Operation	Display
$\log 1.23$ ($\log_{10} 1.23$) = $8.990511144 \times 10^{-2}$	$\boxed{\log} \boxed{1.23} \boxed{\text{EXE}}$	0.08990511144
$\ln 90$ ($\log 90$) = 4.49980967	$\boxed{\ln} \boxed{90} \boxed{\text{EXE}}$	4.49980967
$10^{1.23} = 16.98243652$ (To obtain the antilogarithm of common logarithm 1.23)	$\boxed{\text{SHIFT}} \boxed{10^x} \boxed{1.23} \boxed{\text{EXE}}$	16.98243652
$e^{4.5} = 90.0171313$ (To obtain the antilogarithm of natural logarithm 4.5)	$\boxed{\text{SHIFT}} \boxed{e^x} \boxed{4.5} \boxed{\text{EXE}}$	90.0171313
$10^4 \cdot e^{-4} + 1.2 \cdot 10^{2.3}$ = 422.5878667	$\boxed{\text{SHIFT}} \boxed{10^x} \boxed{4} \boxed{\times} \boxed{\text{SHIFT}} \boxed{e^x} \boxed{\text{SHIFT}} \boxed{(-)} \boxed{4} \boxed{+}$ $\boxed{1.2} \boxed{\times} \boxed{\text{SHIFT}} \boxed{10^x} \boxed{2.3} \boxed{\text{EXE}}$	422.5878667
$5.6^{2.3} = 52.58143837$	$\boxed{5.6} \boxed{^x} \boxed{2.3} \boxed{\text{EXE}}$	52.58143837
$\sqrt[7]{123}$ (= $123^{\frac{1}{7}}$) = 1.988647795	$\boxed{7} \boxed{\text{SHIFT}} \boxed{\sqrt{x}} \boxed{123} \boxed{\text{EXE}}$	1.988647795

2-5 Hyperbolic and Inverse Hyperbolic Functions

•The following calculations cannot be performed in the BASE-N Mode.

Example	Operation	Display
$\sinh 3.6 = 18.28545536$	$\boxed{\text{SHIFT}} \boxed{\text{MATH}} \boxed{\text{F1}} \boxed{\text{(HYP)}} \boxed{\text{F1}} \boxed{\text{(sinh)}} \boxed{3.6} \boxed{\text{EXE}}$	18.28545536
$\cosh^{-1} \left(\frac{20}{15} \right) = 0.7953654612$	$\boxed{\text{SHIFT}} \boxed{\text{MATH}} \boxed{\text{F1}} \boxed{\text{(HYP)}} \boxed{\text{F5}} \boxed{\text{(csh}^{-1}\text{)}} \boxed{\text{C}} \boxed{20} \boxed{\div} \boxed{15} \boxed{\text{EXE}}$	0.7953654612
Determine the value of x when $\tanh 4x = 0.88$		
$x = \frac{\tanh^{-1} 0.88}{4}$ = 0.3439419141	$\boxed{\text{SHIFT}} \boxed{\text{MATH}} \boxed{\text{F1}} \boxed{\text{(HYP)}} \boxed{\text{F6}} \boxed{\text{(tnh}^{-1}\text{)}} \boxed{0.88} \boxed{\div} \boxed{4} \boxed{\text{EXE}}$	0.3439419141

2-6 Other Functions

•The following calculations cannot be performed in the BASE-N Mode.

Example	Operation	Display
$\sqrt{2} + \sqrt{5} = 3.65028154$	$\sqrt{\square} 2 \oplus \sqrt{\square} 5 \text{ EXE}$	3.65028154
$2^2 + 3^2 + 4^2 + 5^2 = 54$	$2 \text{ [SHIFT] } [x^2] \oplus 3 \text{ [SHIFT] } [x^2] \oplus 4 \text{ [SHIFT] } [x^2] \oplus 5 \text{ [SHIFT] } [x^2] \text{ EXE}$	54.
$\frac{1}{\frac{1}{3} - \frac{1}{4}} = 12$	$(\square) 3 \text{ [SHIFT] } [x^{-1}] \ominus 4 \text{ [SHIFT] } [x^{-1}] \text{ [SHIFT] } [x^{-1}] \text{ EXE}$	12.
$8! (= 1 \times 2 \times 3 \times \dots \times 8) = 40320$	$8 \text{ [SHIFT] } [\text{MATH}] [\text{F2}] (\text{PRB}) [\text{F1}] (x!) \text{ EXE}$	40320.
$\sqrt[3]{-27} = -3$	$\text{[SHIFT] } [\sqrt{\square}] \ominus 27 \text{ EXE}$	-3.
$\frac{1}{2!} + \frac{1}{4!} + \frac{1}{6!} + \frac{1}{8!} = 0.5430803571$	$2 \text{ [SHIFT] } [\text{MATH}] [\text{F2}] (\text{PRB}) [\text{F1}] (x!) \text{ [SHIFT] } [x^{-1}] \oplus 4 \text{ [SHIFT] } [x^{-1}] \text{ [SHIFT] } [x^{-1}] \oplus 6 \text{ [SHIFT] } [x^{-1}] \text{ [SHIFT] } [x^{-1}] \oplus 8 \text{ [SHIFT] } [x^{-1}] \text{ [SHIFT] } [x^{-1}] \text{ EXE}$	0.5430803571

2-7 Coordinate Conversion

•Rectangular Coordinates

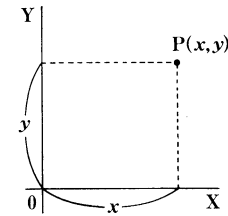

•Polar Coordinates

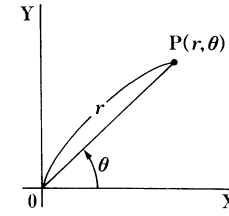

•Calculations results are stored in value memories I and J.

	I	J
Pol	r	θ
Rec	x	y

•With polar coordinates, θ can be calculated within a range of $-180^\circ < \theta \leq 180^\circ$ (radians and grads have same range).

•The following calculations cannot be performed in the BASE-N Mode.

Example	Operation	Display
To calculate r and θ° when $x = 14$ and $y = 20.7$.	$\text{[SHIFT] } [\text{DRG}] [\text{F1}] (\text{Deg}) \text{ EXE}$ $\text{[SHIFT] } [\text{Pol}] 14 \text{ [SHIFT] } [\rightarrow] 20.7 \text{ [SHIFT] } [\rightarrow] \text{ EXE}$ (Continuing) $\text{[ALPHA] } [\text{J}] \text{ EXE}$ $\text{[SHIFT] } [\text{MATH}] [\text{F4}] (\text{DMS}) [\text{F2}] (\delta''''') \text{ EXE}$	24.98979792 (r) 55.92839019 55°55'42.2'' (θ)
To calculate x and y when $r = 4.5$ and $\theta = \frac{2}{3}\pi$ rad.	$\text{[SHIFT] } [\text{DRG}] [\text{F2}] (\text{Rad}) \text{ EXE}$ $\text{[SHIFT] } [\text{Rec}] 4.5 \text{ [SHIFT] } [\rightarrow] (\square) 2 \div 3 \times \text{ EXE}$ $\text{[SHIFT] } [\pi] [\rightarrow] [\rightarrow] \text{ EXE}$ (Continuing) $\text{[ALPHA] } [\text{J}] \text{ EXE}$	-2.25 (x) 3.897114317 (y)

2-8 Permutation and Combination

•Permutation

$${}^nPr = \frac{n!}{(n-r)!}$$

•Combination

$${}^nC_r = \frac{n!}{r!(n-r)!}$$

•The following calculations cannot be performed in the BASE-N Mode.

Example	Operation	Display
To calculate the possible number of different arrangements using 4 items selected from among of 10 items. ${}_{10}P_4 = 5040$	10 SHIFT MATH F2 (PRB) F2 (nPr) 4 EXE	5040.
To calculate the possible number of different combinations of 4 items that can be selected from among 10 items. ${}_{10}C_4 = 210$	10 SHIFT MATH F2 (PRB) F3 (nCr) 4 EXE	210.

2-9 Fractions

- Fractional values are displayed with the integer first, followed by the numerator and then the denominator.
- The following calculations cannot be performed in the BASE-N Mode.

Example	Operation	Display
$\frac{2}{5} + 3\frac{1}{4} = 3\frac{13}{20}$ $= 3.65$ *Fractions can be converted to decimal values and vice versa.	2 α₂ 5 + 3 α₂ 1 α₂ 4 EXE (Conversion to decimal) α₂	3┆13┆20. 3.65
$3\frac{456}{78} = 8\frac{11}{13}$ (Reduced) *Fractions and improper fractions that can be reduced, become reduced fractions when you press a calculation command key. Press SHIFT α₂ to convert the value to an improper fraction.	3 α₂ 456 α₂ 78 EXE (Continuing) SHIFT α₂	8┆11┆13. 115┆13.
$\frac{1}{2578} + \frac{1}{4572}$ $= 6.066202547 \times 10^{-4}$ *When the total number of characters, including integer, numerator, denominator and delimiter mark exceeds 10, the input fraction is automatically displayed in decimal format.	1 α₂ 2578 + 1 α₂ 4572 EXE	6.066202547E-04 (Norm 1 display format)
$\frac{1}{2} \times 0.5 = 0.25$ *Calculations containing both fractions and decimals are calculated in decimal format.	1 α₂ 2 × 0.5 EXE	0.25
$\frac{1}{\frac{1}{3} + \frac{1}{4}} = 1\frac{5}{7}$ *You can include fractions within the numerator or denominator of a fraction by putting the numerator or denominator in parentheses.	1 α₂ (1 α₂ 3 + 1 α₂ 4) EXE	1┆5┆7.

2-10 Engineering Symbol Calculations

•See page 32 for details on selecting engineering symbols.

Example	Operation	Display
999k (kilo) + 25k (kilo) = 1.024M (mega)	999 SHIFT DISP F4 (Eng) EXE 25 SHIFT ENG SYM F6 () F1 (k) + 25 F1 (k) EXE	1.024M 1024000.
	SHIFT DISP F4 (Eng) EXE	
9 ÷ 10 = 0.9 = 900m (milli)	SHIFT DISP F4 (Eng) EXE 9 SHIFT ENG SYM F6 () F1 (k) ÷ 10 F1 (k) EXE	900.m 0.9
	SHIFT ENG	0.0009k
	SHIFT ENG	0.9
	SHIFT ENG	900.m
	SHIFT ENG	900000.μ
	SHIFT ENG	900.m
	SHIFT ENG	

2-11 Number of Decimal Places, Number of Significant Digits, Display Format

- See page 22 for details on specifying the number of decimal places.
- See page 23 for details on specifying the number of significant digits.
- See page 20 for details on specifying the display format.

Example	Operation	Display
100 ÷ 6 = 16.66666666 ... (4 decimal places)	100 SHIFT DISP F4 (Eng) EXE 6 EXE	16.66666667
	SHIFT DISP F1 (Fix) 4 EXE	16.6667
	(Cancels specification) F3 (Nrm) EXE	16.66666667
	(5 significant digits) F2 (Sci) 5 EXE	1.6667E+01
	(Cancels specification) F3 (Nrm) EXE	16.66666667
*Displayed values are rounded off to the place you specify.		
200 ÷ 7 × 14 = 400 (3 decimal places)	200 SHIFT DISP F1 (Fix) 3 EXE ÷ 7 EXE × 14 EXE	400. 400.000
	(Calculation continues using display capacity of 10 digits)	
	200 SHIFT DISP F1 (Fix) 3 EXE ÷ 7 EXE × 14 EXE	28.571 28.57142857 × _ 400.000
	If the same calculation is performed using the specified number of digits:	
	200 SHIFT DISP F1 (Fix) 3 EXE ÷ 7 EXE × 14 EXE	28.571 28.571
(The value stored internally is cut off to the number of decimal places you specify.)		
	SHIFT MATH F3 (NUM) F4 (Rnd) EXE × 14 EXE	28.571 28.571 × _ 399.994
	(Cancels specification) SHIFT DISP F3 (Nrm) EXE	399.994
123m × 456 = 56088m = 56.088km	123 SHIFT MATH F3 (NUM) F4 (Rnd) EXE × 456 EXE SHIFT ENG	56088. 56.088E+03
78g × 0.96 = 74.88g = 0.07488kg	78 SHIFT MATH F3 (NUM) F4 (Rnd) EXE × 0.96 EXE SHIFT ENG	74.88 0.07488E+03

2-12 Calculations Using Memory

•See page 35 for details on value memories.

Example	Operation	Display
	193.2 \rightarrow (ALPHA) (A) (EXE)	193.2
$193.2 \div 23 = 8.4$	(ALPHA) (A) \rightarrow (EXE) 23 (EXE)	8.4
$193.2 \div 28 = 6.9$	(ALPHA) (A) \rightarrow (EXE) 28 (EXE)	6.9
$193.2 \div 42 = 4.6$	(ALPHA) (A) \rightarrow (EXE) 42 (EXE)	4.6
$\frac{9 \times 6 + 3}{(7 - 2) \times 8} = 1.425$	9 \times 6 \rightarrow + 3 \rightarrow (ALPHA) (B) (EXE)	57.
	(\rightarrow) 7 \rightarrow (\rightarrow) 2 (\rightarrow) 8 \rightarrow (ALPHA) (C) (EXE)	40.
	(ALPHA) (B) \rightarrow (ALPHA) (C) (EXE)	1.425
*The same result can be produced by entering (\rightarrow) 9 \times 6 \rightarrow + 3 (\rightarrow) \rightarrow (\rightarrow) 7 (\rightarrow) 2 (\rightarrow) \times 8 (\rightarrow) (EXE).		
$23 + 9 = 32$	23 \rightarrow + 9 \rightarrow (ALPHA) (B) (EXE)	32.
$53 - 6 = 47$	53 \rightarrow - 6 (EXE)	47.
$-) 45 \times 2 = 90$	(ALPHA) (B) \rightarrow + (Ans) \rightarrow (ALPHA) (B) (EXE)	79.
$99 \div 3 = 33$	45 \times 2 (EXE)	90.
Total 22	(ALPHA) (B) \rightarrow - (Ans) \rightarrow (ALPHA) (B) (EXE)	- 11.
	99 \rightarrow + 3 (EXE)	33.
	(ALPHA) (B) \rightarrow + (Ans) \rightarrow (ALPHA) (B) (EXE)	22.
$12 \times (2.3 + 3.4) - 5 = 63.4$	2.3 \rightarrow + 3.4 \rightarrow (ALPHA) (G) (EXE)	5.7
$30 \times (2.3 + 3.4 + 4.5) - 15$	12 \times (ALPHA) (G) \rightarrow 5 (EXE)	63.4
$\times 4.5 = 238.5$	4.5 \rightarrow (ALPHA) (H) (EXE)	4.5
	30 \times (\rightarrow) (ALPHA) (G) \rightarrow + (ALPHA) (H)	
	(\rightarrow) \rightarrow 15 (ALPHA) (H) (EXE)	238.5

*Multiplication signs (\times) immediately before memory names can be omitted.

2-13 BASE-N Mode Calculations

■ Conversions

Example	Operation	Display
	(MODE) \rightarrow (BASE-N)	
To convert $2A_{16}$ to decimal	(F1) (Dec) (EXE)	
	(F5) (d ~ o) (F2) (h) 2A (EXE)	42
	(F4) (o) 27A (EXE)	188
To convert 123_{10} to hexadecimal	(PRE) (F2) (Hex) (EXE)	
	(F5) (d ~ o) (F1) (d) 123 (EXE)	0000007B
	(F3) (b) 1010 (EXE)	0000000A

■ Negative Values

Example	Operation	Display
	(MODE) \rightarrow (BASE-N)	
Negative of 110010_2	(F3) (Bin) (EXE)	
	(F6) (LOG) (F1) (Neg)	
	110010 (EXE)	1111111111001110

■ Arithmetic Operations

Example	Operation	Display
	(MODE) \rightarrow (BASE-N)	
	(F2) (Hex) (EXE)	
$123_8 \times ABC_{16} = 37AF4_{16}$	(F5) (d ~ o) (F4) (o) 123 \times	
	ABC (EXE)	00037/AF4
$= 228084_{10}$	(PRE) (F1) (Dec) (EXE)	228084
$7654_8 \div 12_{10} = 334.3333333_{10}$	(F1) (Dec) (EXE)	
$= 516_8$	(F5) (d ~ o) (F4) (o) 7654 \rightarrow	
	12 (EXE)	334
	(PRE) (F4) (Oct) (EXE)	0000000516

*Fractional parts are cut off before results are displayed.

■ Logical Operations

•See page 40 for details on the logical operations menu.

Example	Operation	Display
$19_{16} \text{ AND } 1A_{16} = 18_{16}$	MODE ■ (BASE-N) F2 (Hex) EXE 19 F6 (LOG) F3 (and) $1A$ EXE	00000018
$1110_2 \text{ AND } 36_8 = 1110_2$	PRE F3 (Bin) EXE 1110 F6 (LOG) F3 (and) PRE F5 (d ~ o) F4 (o) 36 EXE	0000000000001110
$23_8 \text{ OR } 61_8 = 63_8$	PRE F4 (Oct) EXE 23 F6 (LOG) F4 (or) 61 EXE	00000000063
$120_{16} \text{ OR } 1101_2 = 12D_{16}$	PRE F2 (Hex) EXE 120 F6 (LOG) F4 (or) PRE F5 (d ~ o) F3 (b) 1101 EXE	0000012D
$1010_2 \text{ AND } (A_{16} \text{ OR } 7_{16}) = 1010_2$	PRE F3 (Bin) EXE 1010 F6 (LOG) F3 (and) C PRE F5 (d ~ o) F2 (h) A PRE F6 (LOG) F4 (or) PRE F5 (d ~ o) F2 (h) 7 EXE	000000000001010
$5_{16} \text{ XOR } 3_{16} = 6_{16}$	PRE F2 (Hex) EXE 5 F6 (LOG) F5 (xor) 3 EXE	00000006
$2A_{16} \text{ XNOR } 5D_{16} = \text{FFFFFF}88_{16}$	PRE F2 (Hex) EXE $2A$ F6 (LOG) F6 (xnor) $5D$ EXE	FFFFFFF88
Negation of 1234_8	PRE F4 (Oct) EXE F6 (LOG) F2 (Not) 1234 EXE	3777776543
Negation of 2FFFD_{16}	PRE F2 (Hex) EXE F6 (LOG) F2 (Not) 2FFFD EXE	FFD00012

Chapter

3

Integration Calculations

3-1 How the Unit Calculates Integrations

Chapter 3 Integration Calculations

This chapter tells you how to perform integration calculations on the unit.

3-1 How the Unit Calculates Integrations

The following is the input format for integrations:

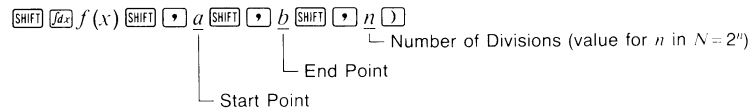

$$\int (f(x), a, b, n) \Rightarrow \int_a^b f(x) dx, N=2^n$$

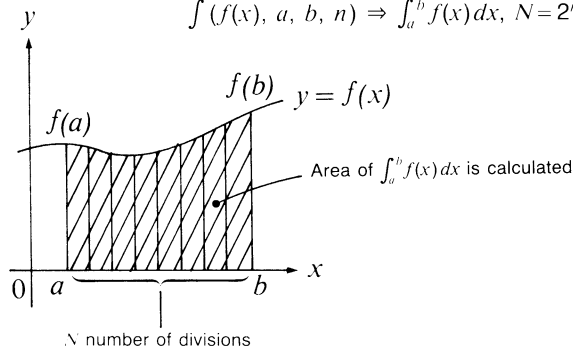

Integration calculations are performed by applying Simpson's Rule for the $f(x)$ function you input. This method requires that the number of divisions be defined. You can specify a value for n (an integer in the range of 1 through 9) to be applied in $N=2^n$ for the number of divisions. If you do not specify the number of divisions, the calculator automatically assigns a value.

Also note that the calculator uses the following value memories to store data during integration calculations.

Value Memory	K	L	M	N
Data Stored	a	b	$N=2^n$	$\int_a^b (f(x)) dx$

To perform an integration calculation

Example To perform the integration calculation for the function $\int_1^5 (2x^2 + 3x + 4) dx$

Input the function.

$\text{[SHIFT] [}\int dx\text{] } 2 \text{ [X,}\theta\text{,T] [SHIFT] [X}^2\text{] } 3 \text{ []}$
 $\text{[X,}\theta\text{,T] } 4 \text{ [SHIFT] []}$

$\int (2X^2+3X+4, _ _$

Input the start point and end point.

$1 \text{ [SHIFT] [] } 5 \text{ [SHIFT] []}$

$\int (2X^2+3X+4, 1, 5, _$

Input the number of divisions.

6 []

$\int (2X^2+3X+4, 1, 5, 6$
 $) _$

Execute the calculation.

[EXE]

$\int (2X^2+3X+4, 1, 5, 6$
 $)$
 134.6666667

The result takes a few seconds to appear on the display.

[ALPHA] [K] [EXE]

K 1. | a

[ALPHA] [L] [EXE]

L 5. | b

[ALPHA] [M] [EXE]

M 64. | N

[ALPHA] [N] [EXE]

N 134.6666667

You can confirm the parameters of this calculation by recalling the values stored in the value memories.

$\bullet f(x)$ can use the X value memory name only. If you use any other value memory name, it is regarded as a constant and the corresponding memory contents are applied.

Application of integration calculation

Integrals or results of integration calculations can be used in arithmetic calculations.

Example $\int_a^b f(x) dx + \int_c^d g(x) dx$, $2 \times \int_a^b f(x) dx$, etc.

*Results of integration calculation cannot be used in integration calculation formulas.

•When calculating area as shown below, Abs (absolute value) should be inserted into formula:

$$\int (\text{Abs } f(x), a, b, n) \Rightarrow \int_a^b |f(x)| dx$$

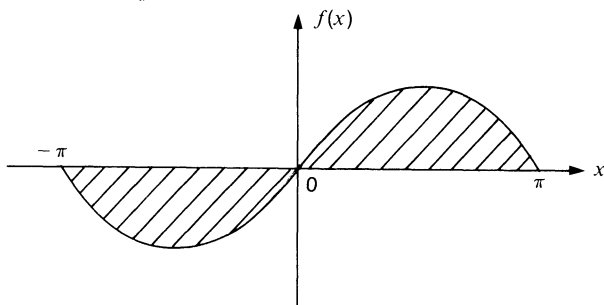

Example Calculate the $[-\pi, \pi]$ areas of $f(x) = \sin x$. Omit input of number of divisions.

First, specify the unit of angular measurement as radians.

$\text{SHIFT} \text{DRG} \text{F2} (\text{Rad}) \text{EXE}$

Rad 0.

Input the function.

$\text{SHIFT} \sqrt{dx} \text{SHIFT} \text{MATH} \text{F3} (\text{NUM})$

$\text{F1} (\text{Abs}) \text{sin} \text{K} \text{.T} \text{SHIFT} \text{}$

$\int (\text{Abs } \sin X, _$

Input the start point and end point.

$\text{SHIFT} (\leftarrow) \text{SHIFT} \pi \text{SHIFT} \text{}$

$\pi \text{}$

$\int (\text{Abs } \sin X, -\pi, \pi$
 $) _$

Execute the calculation.

EXE

$\int (\text{Abs } \sin X, -\pi, \pi$
 $)$
4.

The result takes a few seconds to appear on the display.

$\text{ALPHA} \text{K} \text{EXE}$

K -3.141592654 a

$\text{ALPHA} \text{L} \text{EXE}$

L 3.141592654 b

$\text{ALPHA} \text{M} \text{EXE}$

M 64. N

$\text{ALPHA} \text{N} \text{EXE}$

N 4. $\int_a^b f(x) dx$

Important

- Pressing the **AC** key during calculation of an integration (while the display is cleared) interrupts the calculation.
- Always perform trigonometric integrations using radians as the unit of angular measurement (see page 20).
- Integration calculations use value memories K through N for storage, deleting any contents that may be already stored. This also means that you cannot use these value memories during integration calculations.

Value Memory	K	L	M	N
Data Stored	a	b	$N = 2^n$	$\int_a^b (f(x)) dx$

In addition to the above, the value that represents division beginning point a is stored in value memory X following completion of the integration calculation.

- This unit utilizes Simpson's rule for integration calculation. As number of significant digits is increased, extended calculation time is required. In some cases, calculation results may be erroneous even after considerable time expires in calculation. In particular, when significant digits are less than 1, an ERROR (Ma ERROR) sometimes occurs. In this case, the following procedures can be used to break the calculation down, thus reducing calculation time while improving calculation accuracy.
 - (1) When minute fluctuations in integration divisions produce large fluctuations in integration values, calculate the integration divisions separately (divide the large fluctuation areas into smaller divisions), and then add the results together.
 - (2) When cyclical functions for integration values become positive or negative for different divisions, perform the calculation for single cycles, or divide between negative and positive, and then add the results together.

Statistical Calculations

• Integration involving certain types of functions or ranges can result in relatively large errors being generated in the values produced. Note the following points to ensure correct integration values.

- (1) When cyclical functions for integration values become positive or negative for different divisions, perform the calculation for single cycles, or divide between negative and positive, and then add the results together.

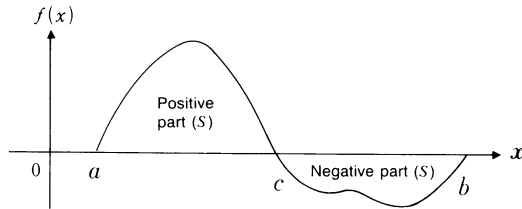

$$\int_a^b f(x) dx = \underbrace{\int_a^c f(x) dx}_{\text{Positive part (S)}} + \underbrace{\left(-\int_c^b f(x) dx\right)}_{\text{Negative part (S)}}$$

Example The integration values for the divisions of $f(x) = \cos x$ ($0, 2\pi$) are shown below.

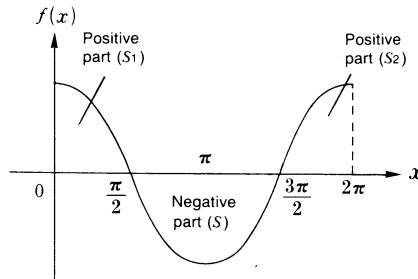

$$\int_0^{2\pi} \cos x dx = \underbrace{\int_0^{\pi/2} \cos x dx}_{\text{Positive part (S}_1)} + \underbrace{\left(-\int_{\pi/2}^{3\pi/2} \cos x dx\right)}_{\text{Negative part (S)}} + \underbrace{\int_{3\pi/2}^{2\pi} \cos x dx}_{\text{Positive part (S}_2)}$$

- (2) When minute fluctuations in integration divisions produce large fluctuations in integration values, calculate the integration divisions separately (divide the large fluctuation areas into smaller divisions), and then add the results together.

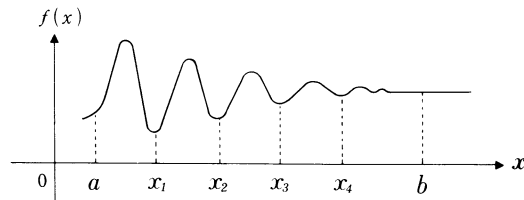

$$\int_a^b f(x) dx = \int_a^{x_1} f(x) dx + \int_{x_1}^{x_2} f(x) dx + \dots + \int_{x_4}^b f(x) dx$$

Chapter 4

Statistical Calculations

There are two types of statistical calculations: *single-variable statistical calculations* performed using standard deviation, and *paired-variable statistical calculations* performed using regression.

Regression calculations can be performed using linear regression, logarithmic regression, exponential regression and power regression.

No matter what type of statistical calculations you decide to perform, you can tell the unit to either store the statistical data or not to store the data. If you choose not to store the data, be sure to use the following operation to clear memory contents before beginning calculations. Immediately after switching power on, enter: **SHIFT CLR F2(Scl) EXE**

4-1 Single-Variable Statistical Calculations

You should use the Standard Deviation Mode to perform single-variable statistical calculations. In this mode, you can calculate the population standard deviation, the sample standard deviation, the mean, the sum of squares of the data, the sum of the data, and the number of data items.

■ To enter the Standard Deviation Mode without data storage

MODE **SHIFT**

2 specifies non-storage of data.

```
Stat data
1:STO
2:NON-
```

MODE

```
Cal mode
+:COMP
-:BASE-N
x:SD
÷:REG
∅:MATRIX
```

X (SD)

Once you complete the above operation, the status display should appear as shown right.

```

  RUN / SD
  ① S-data : NON-
  ② S-graph: NON-
  ③ G-type  : REC/CON
  ④ angle   : Deg
  ⑤ display: Nrm1
  DT CL : DEV Σ PQR
  F1  F2  F3  F4  F5  F6
```

- ① Indicates storage (STO) or non-storage (NON-) of statistical data
- ② Indicates drawing (DRAW) or non-drawing (NON-) of a statistical graph
- ③ Graph type
- ④ Unit of angular measurement
- ⑤ Display format

The following are the operations that are available from the function display at the bottom of the screen. Press the function key below the operation you want to perform.

- F1**(DT) Inputs data
- F2**(CL) Clears data
- F3**(;) Used to input the number of data items
- F4**(DEV) Displays a standard deviation function menu
- F5**(Σ) Displays a data sum function menu
- F6**(PQR) Displays a probability distribution function menu

The unit uses the following value memories to store values. Do not use these memories for storage if you plan to perform statistical operations.

Value Memory	U	V	W
Statistical Data	Σx^2	Σx	n

● To input data

Example 1 To input the data 10, 20, 30

10 **F1**(DT) 20 **F1**(DT) 30 **F1**(DT)

Example 2 To input the data 10, 20, 20, 30

10 **F1**(DT) 20 **F1**(DT) **F1**(DT) 30 **F1**(DT)

Note that simply pressing **F1**(DT) inputs the previously entered data.

Example 3 To input the data 10, 20, 20, 20, 20, 20, 20, 30

10 **F1**(DT) 20 **F3**(;) 6 **F1**(DT) 30 **F1**(DT)

Note that you can input multiple data items by entering the data, pressing **F3**(;), and then entering the number of data items.

● To delete data

Example 1 Data input sequence: 40 $\boxed{F1}$ (DT) 20 $\boxed{F1}$ (DT) 30 $\boxed{F1}$ (DT) 50 $\boxed{F1}$ (DT)

To delete the 50 $\boxed{F1}$ (DT) (last data item entered), press $\boxed{F2}$ (CL).

Example 2 Data input sequence: 40 $\boxed{F1}$ (DT) 20 $\boxed{F1}$ (DT) 30 $\boxed{F1}$ (DT) 50 $\boxed{F1}$ (DT)

To delete the 20 $\boxed{F1}$ (DT), enter 20 $\boxed{F2}$ (CL).

Example 3 Data input sequence: 30 $\boxed{F1}$ (DT) 50 $\boxed{F1}$ (DT) 120 $\boxed{F3}$ (;)

To delete the 120 $\boxed{F3}$ (;), press \boxed{AC} .

Example 4 Data input sequence: 30 $\boxed{F1}$ (DT) 50 $\boxed{F1}$ (DT) 120 $\boxed{F3}$ (;) 31

To delete the 120 $\boxed{F3}$ (;)31, press \boxed{AC} .

Example 5 Data input sequence: 30 $\boxed{F1}$ (DT) 50 $\boxed{F1}$ (DT) 120 $\boxed{F3}$ (;) 31 $\boxed{F1}$ (DT)

To delete the 120 $\boxed{F3}$ (;)31 $\boxed{F1}$ (DT) (last item entered), press $\boxed{F2}$ (CL).

Example 6 Data input sequence: 50 $\boxed{F1}$ (DT) 120 $\boxed{F3}$ (;) 31 $\boxed{F1}$ (DT) 30 $\boxed{F1}$ (DT)

To delete the 120 $\boxed{F3}$ (;)31 $\boxed{F1}$ (DT), enter 120 $\boxed{F3}$ (;)31 $\boxed{F2}$ (CL).

■ To enter the Standard Deviation Mode with data storage

\boxed{MODE} \boxed{SHIFT}

$\boxed{1}$ specifies storage of data.

```
Stat data
1:STO
2:NON-
```

\boxed{MODE}

```
Cal mode
+:COMP
-:BASE-N
x:SD
÷:REG
ø:MATRIX
```

\boxed{X} (SD)

Once you complete the above operation, the status display should appear as shown right.

```

  ① RUN / SD
  ② S-data : STO
  ③ S-graph : NON-
  ④ G-type  : REC/CON
  ⑤ angle   : Deg
  display  : Nrm1

  DT EDIT ; DEV Σ PQR
  F1  F2  F3  F4  F5  F6
```

- ① Indicates storage (STO) or non-storage (NON-) of statistical data
- ② Indicates drawing (DRAW) or non-drawing (NON-) of a statistical graph
- ③ Graph type
- ④ Unit of angular measurement
- ⑤ Display format

The following are the operations that are available from the function display at the bottom of the screen. Press the function key below the operation you want to perform.

- $\boxed{F1}$ (DT) Inputs data
- $\boxed{F2}$ (EDIT) Displays an edit function menu
- $\boxed{F3}$ (;) Used to input the number of data items
- $\boxed{F4}$ (DEV) Displays a standard deviation function menu
- $\boxed{F5}$ (Σ) Displays a data sum function menu
- $\boxed{F6}$ (PQR) Displays a probability distribution function menu

- Σx^2 , Σx , and n data are stored in their own memory area, and so they do not use value memories.
- See pages 105 and 131 for the formulas used to calculate standard deviation, mean, and probability distribution.
- The maximum value is the largest value input for X, while the minimum value is the smallest value input for X.
- The median is the middle value of the data. If the number of data items is a negative value, or if it is greater than 10^{10} , or if the data includes a data item of 0, an Ma ERROR occurs.

● To input data

Example 1 To input the data 10, 20, 30

Before actually beginning data input, use the following sequence to delete any statistical data stored in memory.

$\boxed{F2}$ (EDIT) $\boxed{F3}$ (ERS) $\boxed{F1}$ (YES)
10 $\boxed{F1}$ (DT) 20 $\boxed{F1}$ (DT) 30 $\boxed{F1}$ (DT)

Example 2 To input the data 10, 20, 20, 30

10 $\boxed{F1}$ (DT) 20 $\boxed{F1}$ (DT) $\boxed{F1}$ (DT) 30 $\boxed{F1}$ (DT)

Note that simply pressing $\boxed{F1}$ (DT) inputs the previously entered data.

Example 3 To input the data 10, 20, 20, 20, 20, 20, 30

10 $\boxed{F1}$ (DT) 20 $\boxed{F3}$ (;) 6 $\boxed{F1}$ (DT) 30 $\boxed{F1}$ (DT)

Note that you can input multiple data items by entering the data, pressing $\boxed{F3}$ (;), and then entering the number of data items.

● To edit data items stored in memory

Example To change 50 to 54

F2(EDIT)



	X	f
1	52	1
2	52	1
3	50	1
4	58	2
5	56	1

50.

DEL INS ERS

5 **4**

	X	f
1	52	1
2	52	1
3	50	1
4	58	2
5	56	1

54_

DEL INS ERS

EXE

	X	f
1	52	1
2	52	1
3	54	1
4	58	2
5	56	1

1.

DEL INS ERS

After you finish editing the data, press **PRE** and then **F6**(CAL) (see page 104).

PRE

DT	EDIT	:	CAL
-----------	-------------	----------	------------

F6

F6(CAL)

DT	EDIT	:	DEV	Σ	PQR
-----------	-------------	----------	------------	----------	------------

● To delete specific data items stored in memory

Example To delete 54

F2(EDIT)



	X	f
1	52	1
2	52	1
3	54	1
4	58	2
5	56	1

54.

DEL INS ERS

F1

F1(DEL)

	X	f
1	52	1
2	52	1
3	58	2
4	56	1

58.

DEL INS ERS

After you finish deleting the data, press **PRE** and then **F6**(CAL) (see page 104).

• To insert data items into data stored in memory

Example To insert 0 between 52 and 58

F2(EDIT)



	X	f
1	52	1
2	52	1
3	58	2
4	56	1
5	45	1

58.

DEL INS ERS

F2

F2(INS)

	X	f
1	52	1
2	52	1
3	0	1
4	58	2
5	56	1

0.

DEL INS ERS

After you finish inserting the data, press **PRE** and then **F6**(CAL) (see page 104).

• To clear all statistical data

F3(ERS)

YES ERASE ALL DATA **NO**

F1 **F6**

Press **F1**(YES) to clear all statistical data from memory or **F6**(NO) (or **PRE**) to abort this procedure without deleting anything.

4-2 Paired-Variable Statistical Calculations

You should use the Regression Mode to perform paired-variable statistical calculations. In this mode, you can perform linear regression, logarithmic regression, exponential regression, and power regression.

■ To enter the Regression Mode without data storage

MODE **SHIFT**

2 specifies non-storage of data.

MODE

Stat data
1:STO
2:NON-

Sys mode	Cal mode
1:RUN	+:COMP
2:WRT	-:BASE-N
3:PCL	x:SD
REG model	÷:REG
4:LIN	∅:MATRIX
5:LOG	Contrast
6:EXP	←:LIGHT
7:PWR	→:DARK

Note that you can also select the regression type using this screen.

- 4: Linear regression
- 5: Logarithmic regression
- 6: Exponential regression
- 7: Power regression

REG(REG)

Once you complete the above operation, the status display should appear as shown right.

① — RUN / LIN-REG
 ② S-data : NON-
 ③ S-graph : NON-
 ④ G-type : REC/CON
 ⑤ angle : Deg
 ⑥ display : Nrm1

DT CL ; DEV Σ REG

F1 F2 F3 F4 F5 F6

- ① Indicates the mode (linear regression in this example)
- ② Indicates storage (STO) or non-storage (NON-) of statistical data
- ③ Indicates drawing (DRAW) or non-drawing (NON-) of a statistical graph
- ④ Graph type
- ⑤ Unit of angular measurement
- ⑥ Display format

The following are the operations that are available from the function display at the bottom of the screen. Press the function key below the operation you want to perform.

- F1** (DT) Inputs data
- F2** (CL) Clears data
- F3** (;) Used to input the number of data pairs
- F4** (DEV) Displays a standard deviation function menu
- F5** (Σ) Displays a data sum function menu
- F6** (REG) Displays a regression function menu

The unit uses the following value memories to store values. Do not use these memories for storage if you plan to perform statistical operations.

Value Memory	P	Q	R	U	V	W
Statistical Data	Σy^2	Σy	Σxy	Σx^2	Σx	n

■ To enter the Linear Regression Mode

MODE

REG model

- 4: LIN
- 5: LOG
- 6: EXP
- 7: PWR

4 (LIN)

RUN / LIN-REG

The linear regression formula is $y = A + Bx$.

● To input data for linear regression

Example 1 To input the data 10/20, 20/30, 20/30, 40/50

- 10 **SHIFT** **F1** (DT)
- 20 **SHIFT** **F1** (DT)
- F1** (DT)
- 40 **SHIFT** **F1** (DT)

Example 2 To input the data 10/20, 20/30, 20/30, 20/30, 20/30, 20/30, 40/50

- 10 **SHIFT** **F1** (DT)
- 20 **SHIFT** **F3** (;) **F1** (DT)
- 40 **SHIFT** **F1** (DT)

Note that you can input multiple data pairs by entering the data, pressing **F3** (;), and then entering the number of data pairs.

● To delete data

Example 1 Data input sequence: 10 **SHIFT** **F1** (DT)
 20 **SHIFT** **F1** (DT)
 30 **SHIFT** **F1** (DT)
 40 **SHIFT** **F1** (DT)

To delete the 40 **SHIFT** **F1** (DT) (last data pair entered), press **F2** (CL).

Example 2 Data input sequence: 10 **SHIFT** **F1** (DT)
 20 **SHIFT** **F1** (DT)
 30 **SHIFT** **F1** (DT)
 40 **SHIFT** **F1** (DT)

To delete the 40 **SHIFT** **F1** (DT), press **AC**.

Example 3 Data input sequence: 10 **SHIFT** **F1** (DT)
 20 **SHIFT** **F1** (DT)
 30 **SHIFT** **F1** (DT)
 40 **SHIFT** **F1** (DT)

To delete the 20 **SHIFT** **F1** (DT), enter 20 **SHIFT** **F2** (CL).

● To calculate results

After you enter data, press **F6** (REG) for the regression menu, and press the function key that corresponds to the result you want to display.

- F1** (A) Constant term A
- F2** (B) Regression coefficient B
- F3** (r) Correlation coefficient r
- F4** (\hat{x}) Estimated value of x
- F5** (\hat{y}) Estimated value of y

■ To enter the Logarithmic Regression Mode

MODE

REG model

4:LIN
5:LOG
6:EXP
7:PWR

5 (LOG)

RUN / LOG-REG

The logarithmic regression formula is $y = A + B \cdot \ln x$.

● To input data for logarithmic regression

Input data using the same procedures as described for linear regression on page 98.

● To delete data

Delete data using the same procedures as described for linear regression on page 99.

● To calculate results

After you enter data, press $\boxed{F6}$ (REG) for the regression menu, and press the function key that corresponds to the result you want to display.

- $\boxed{F1}$ (A) Constant term A
- $\boxed{F2}$ (B) Regression coefficient B
- $\boxed{F3}$ (r) Correlation coefficient r
- $\boxed{F4}$ (\hat{x}) Estimated value of x
- $\boxed{F5}$ (\hat{y}) Estimated value of y

The following shows the equivalent values between linear regression and logarithmic regression.

Linear Regression	Logarithmic Regression
Σx	$\Sigma \ln x$
Σx^2	$\Sigma (\ln x)^2$
Σxy	$\Sigma \ln x \cdot y$

■ To enter the Exponential Regression Mode

MODE

REG model

4:LIN
5:LOG
6:EXP
7:PWR

6 (EXP)

RUN / EXP-REG

The exponential regression formula is $y = A \cdot e^{B \cdot x}$ ($\ln y = \ln A + Bx$).

● To input data for exponential regression

Input data using the same procedures as described for linear regression on page 98.

● To delete data

Delete data using the same procedures as described for linear regression on page 99.

● To calculate results

After you enter data, press $\boxed{F6}$ (REG) for the regression menu, and press the function key that corresponds to the result you want to display.

- $\boxed{F1}$ (A) Constant term A
- $\boxed{F2}$ (B) Regression coefficient B
- $\boxed{F3}$ (r) Correlation coefficient r
- $\boxed{F4}$ (\hat{x}) Estimated value of x
- $\boxed{F5}$ (\hat{y}) Estimated value of y

The following shows the equivalent values between linear regression and exponential regression.

Linear Regression	Exponential Regression
Σy	$\Sigma \ln y$
Σy^2	$\Sigma (\ln y)^2$
Σxy	$\Sigma x \cdot \ln y$

■ To enter the Power Regression Mode

MODE

REG model

4:LIN
5:LOG
6:EXP
7:PWR

7 (PWR)

RUN / PWR-REG

The power regression formula is $y = A \cdot x^B$ ($\ln y = \ln A + B \ln x$).

● To input data for power regression

Input data using the same procedures as described for linear regression on page 98.

● To delete data

Delete data using the same procedures as described for linear regression on page 99.

● To calculate results

After you enter data, press $\boxed{\text{REG}}$ (REG) for the regression menu, and press the function key that corresponds to the result you want to display.

- $\boxed{\text{F1}}$ (A) Constant term A
- $\boxed{\text{F2}}$ (B) Regression coefficient B
- $\boxed{\text{F3}}$ (r) Correlation coefficient r
- $\boxed{\text{F4}}$ (\hat{x}) Estimated value of x
- $\boxed{\text{F5}}$ (\hat{y}) Estimated value of y

The following shows the equivalent values between linear regression and power regression.

Linear Regression	Power Regression
Σx	$\Sigma \ln x$
Σx^2	$\Sigma (\ln x)^2$
Σy	$\Sigma \ln y$
Σy^2	$\Sigma (\ln y)^2$
Σxy	$\Sigma \ln x \cdot \ln y$

■ To enter the Regression Mode with data storage

MODE SHIFT

1 specifies storage of data.

MODE

Stat data

1:STO
2:NON-

Sys mode Cal mode

1:RUN
2:WRT
3:PCL
REG model
4:LIN
5:LOG
6:EXP
7:PWR

+:COMP
-:BASE-N
x:SD
÷:REG
O:MATRIX

Contrast

←:LIGHT
→:DARK

Note that you can also select the regression type using this screen.

- 4: Linear regression
- 5: Logarithmic regression
- 6: Exponential regression
- 7: Power regression

$\boxed{\text{REG}}$ (REG)

Once you complete the above operation, the status display should appear as shown right.

① — RUN / LIN-REG
② S-data : STO
③ S-graph : NON-
④ G-type : REC/CON
⑤ angle : Deg
⑥ display : Nrm1

$\boxed{\text{DT}}$ $\boxed{\text{EDIT}}$: $\boxed{\text{DEV}}$ $\boxed{\Sigma}$ $\boxed{\text{REG}}$

$\boxed{\text{F1}}$ $\boxed{\text{F2}}$ $\boxed{\text{F3}}$ $\boxed{\text{F4}}$ $\boxed{\text{F5}}$ $\boxed{\text{F6}}$

- ① Indicates the mode (linear regression in this example)
- ② Indicates storage (STO) or non-storage (NON-) of statistical data
- ③ Indicates drawing (DRAW) or non-drawing (NON-) of a statistical graph
- ④ Graph type
- ⑤ Unit of angular measurement
- ⑥ Display format

The following are the operations that are available from the function display at the bottom of the screen. Press the function key below the operation you want to perform.

- $\boxed{\text{F1}}$ (DT) Inputs data
- $\boxed{\text{F2}}$ (EDIT) Displays an edit function menu
- $\boxed{\text{F3}}$ (;) Used to input the number of data pairs
- $\boxed{\text{F4}}$ (DEV) Displays a standard deviation function menu
- $\boxed{\text{F5}}$ (Σ) Displays a data sum function menu
- $\boxed{\text{F6}}$ (REG) Displays a regression function menu

• Σx^2 , Σx , n , Σy^2 , Σy , and Σxy data are stored in their own memory area, and so they do not use value memories.

• To input data

The following input procedures can be used to input data for linear, logarithmic, exponential, and power regression.

Before actually beginning data input, use the following sequence to delete any statistical data stored in memory.

F2(EDIT)

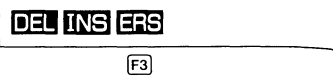

F3(ERS)



F1(YES)



Example 1 To input the data 10/20, 20/30, 20/30, 40/50

10 **SHIFT** **20** **F1** (DT)

20 **SHIFT** **30** **F1** (DT)

F1 (DT)

40 **SHIFT** **50** **F1** (DT)

Example 2 To input the data 10/20, 20/30, 20/30, 20/30, 20/30, 20/30, 40/50

10 **SHIFT** **20** **F1** (DT)

20 **SHIFT** **30** **F3** (;) **F1** (DT)

40 **SHIFT** **50** **F1** (DT)

Note that you can input multiple data pairs by entering the data, pressing **F3** (;), and then entering the number of data pairs.

• To edit data

To change, delete, insert, or clear data, press **F2**(EDIT) to display the edit function menu and then perform the same procedures as those described for single-variable data on pages 94 ~ 96.

4-3 Things to Remember during Statistical Calculations

Anytime you delete, insert, or otherwise edit statistical data, be sure to press **PRE** and then **F6**(CAL) to re-calculate the statistical results before inputting new data or performing any other calculation. You should also press **PRE** followed by **F6**(CAL) after you delete the statistical data memory using Scl (**SHIFT** **CLR** **F2**(Scl)).

4-4 Examples of Statistical Calculations

The following are the formulas used by the unit to calculate standard deviation and mean.

•Standard Deviation

$$\sigma_n = \sqrt{\frac{\sum_{i=1}^n (x_i - \bar{x})^2}{n}} = \sqrt{\frac{\sum x^2 - (\sum x)^2/n}{n}}$$

Using all data from a finite population to determine the standard deviation for the population

$$\sigma_{n-1} = \sqrt{\frac{\sum_{i=1}^n (x_i - \bar{x})^2}{n-1}} = \sqrt{\frac{\sum x^2 - (\sum x)^2/n}{n-1}}$$

Using sample data from a population to determine the standard deviation for the population

•Mean

$$\bar{x} = \frac{\sum_{i=1}^n x_i}{n} = \frac{\sum x}{n}$$

Example	Operation	Display
Data 55, 54, 51, 55, 53, 53, 54, 52	MODE 2 (SD) MODE SHIFT 2 (Stat data: NON-) SHIFT CLR F2 (Scl) EXE PRE (Clears memory)	
	55 F1 (DT) 54 F1 (DT)	
	51 F1 (DT) 55 F1 (DT)	
	53 F1 (DT) F1 (DT) 54 F1 (DT)	
	52 F1 (DT)	52.
	*You can press the function keys to obtain results in any sequence.	
	(Standard deviation σ_n) F4 (DEV) F2 ($x\sigma_n$) EXE	1.316956719
	(Standard deviation σ_{n-1}) F3 ($x\sigma_{n-1}$) EXE	1.407885953
	(Mean \bar{x}) F1 (\bar{x}) EXE	53.375
	(Number of data n) PRE F5 (Σ) F3 (n) EXE	8.
	(Sum total Σx) F2 (Σx) EXE	427.
	(Sum of squares Σx^2) F1 (Σx^2) EXE	22805.

To calculate the deviation of the unbiased variance, the difference between each datum, and mean of the above data

To calculate \bar{x} and σ_{n-1} for the following data

Class no.	Value	Frequency
1	110	10
2	130	31
3	150	24
4	170	2
5	190	3

(Continuing) **PRE** **F4** (DEV) **F3**
 $(x\sigma_{n-1})$ **SHIFT** **X²** **EXE**
55 **F1** (\bar{x}) **EXE**
54 **F1** (\bar{x}) **EXE**
51 **F1** (\bar{x}) **EXE**
 ⋮

SHIFT **CLR** **F2** (ScI) **EXE** **PRE** **PRE**

110 **F3** (;) **10** **F1** (DT) **110.**
130 **F3** (;) **31** **F1** (DT) **130.**
150 **F3** (;) **24** **F1** (DT) **150.**
170 **F1** (DT) **F1** (DT) **170.**
170.
190 **F1** (DT) **F1** (DT) **F1** (DT) **190.**
190.
190.
70.
F5 (Σ) **F3** (n) **EXE** **137.7142857**
PRE **F4** (DEV) **F1** (\bar{x}) **EXE** **18.42898069**
F3 ($x\sigma_{n-1}$) **EXE**

• Regression

The following are the formulas the unit uses to calculate constant term A and regression coefficient B for the regression formula $y = A + Bx$.

$$A = \frac{\Sigma y - B \cdot \Sigma x}{n} \quad B = \frac{n \cdot \Sigma xy - \Sigma x \cdot \Sigma y}{n \cdot \Sigma x^2 - (\Sigma x)^2}$$

The following is the formula the unit uses to calculate correlation coefficient r .

$$r = \frac{n \cdot \Sigma xy - \Sigma x \cdot \Sigma y}{\sqrt{\{n \cdot \Sigma x^2 - (\Sigma x)^2\} \{n \cdot \Sigma y^2 - (\Sigma y)^2\}}}$$

$$\hat{y} = A + Bx \quad \hat{x} = \frac{y - A}{B}$$

■ Linear Regression

Example	Operation	Display												
•Relationship between temperature and the length of a steel bar <table border="1" style="margin-top: 10px;"> <thead> <tr> <th>Temperature</th> <th>Length</th> </tr> </thead> <tbody> <tr> <td>10°C</td> <td>1003mm</td> </tr> <tr> <td>15°C</td> <td>1005mm</td> </tr> <tr> <td>20°C</td> <td>1010mm</td> </tr> <tr> <td>25°C</td> <td>1011mm</td> </tr> <tr> <td>30°C</td> <td>1014mm</td> </tr> </tbody> </table>	Temperature	Length	10°C	1003mm	15°C	1005mm	20°C	1010mm	25°C	1011mm	30°C	1014mm	MODE 4 (REG) MODE 4 (LIN) MODE SHIFT 2 (Stat data: NON-) SHIFT CLR F2 (ScI) EXE PRE (Clears memory)	
	Temperature	Length												
	10°C	1003mm												
	15°C	1005mm												
	20°C	1010mm												
	25°C	1011mm												
	30°C	1014mm												
		10 SHIFT ▷ 1003 F1 (DT)	10.											
		15 SHIFT ▷ 1005 F1 (DT)	15.											
		20 SHIFT ▷ 1010 F1 (DT)	20.											
	25 SHIFT ▷ 1011 F1 (DT)	25.												
	30 SHIFT ▷ 1014 F1 (DT)	30.												
	(Constant term A) F6 (REG) F1 (A) EXE	997.4												
	(Regression coefficient B) F2 (B) EXE	0.56												
	(Correlation coefficient r) F3 (r) EXE	0.9826073689												
	(Length at 18°C) 18 F5 (\hat{y}) EXE	1007.48												
	(Temperature at 1000mm) 1000 F4 (\hat{x}) EXE	4.642857143												
	(Critical coefficient) F3 (r) SHIFT X² EXE	0.9655172414												
	(Covariance) PRE F5 (Σ) F6 (Σxy) EXE F3 (n) EXE PRE F4 (DEV) F1 (\bar{x}) EXE EXE F4 (\bar{y}) EXE PRE F5 (Σ) EXE F3 (n) EXE 1 EXE	35.												

The data in the above table can be used to obtain the terms of the regression formula and the correlation coefficient. Based on the regression formula, the estimated length of the steel bar at 18°C and the temperature when the bar is 1000 mm long can be calculated. The critical coefficient (r^2) and covariance

$$\frac{\Sigma xy - n \cdot \bar{x} \cdot \bar{y}}{n - 1}$$

can also be calculated.

■ Logarithmic Regression

- The logarithmic regression formula is $y = A + B \cdot \ln x$.
- Σx , Σx^2 , and Σxy are obtained as $\Sigma \ln x$, $\Sigma (\ln x)^2$, and $\Sigma \ln x \cdot y$ respectively.

Example		Operation	Display
xi	yi		
29	1.6	MODE REG (LOG)	
50	23.5	MODE SHIFT 2 (Stat data: NON-)	
74	38.0	SHIFT CLR F2 (Sci) EXE PRE	
103	46.4	(Clears memory)	
118	48.9	29 SHIFT ▷ 1.6 F1 (DT)	3.36729583
		50 SHIFT ▷ 23.5 F1 (DT)	3.912023005
		74 SHIFT ▷ 38.0 F1 (DT)	4.304065093
		103 SHIFT ▷ 46.4 F1 (DT)	4.634728988
		118 SHIFT ▷ 48.9 F1 (DT)	4.770684624
		(Constant term A)	
		F6 (REG) F1 (A) EXE	-111.1283976
		(Regression coefficient B)	
		F2 (B) EXE	34.0201475
		(Correlation coefficient r)	
		F3 (r) EXE	0.9940139466
		(\hat{y} when $xi = 80$) 80 F5 (\hat{y}) EXE	37.94879482
		(\hat{x} when $yi = 73$) 73 F4 (\hat{x}) EXE	224.1541313

The data in the above table can be used to obtain the terms of the regression formula and the correlation coefficient. Based on the regression formula, estimated value \hat{y} can be obtained for $xi = 80$, and estimated value \hat{x} can be obtained for $yi = 73$.

■ Exponential Regression

- The exponential regression formula is $y = A \cdot e^{B \cdot x}$ ($\ln y = \ln A + Bx$).
- Σy is obtained as $\Sigma \ln y$, Σy^2 as $\Sigma (\ln y)^2$, and Σxy as $\Sigma x \cdot \ln y$.

Example		Operation	Display
xi	yi		
6.9	21.4	MODE REG (EXP)	
12.9	15.7	MODE SHIFT 2 (Stat data: NON-)	
19.8	12.1	SHIFT CLR F2 (Sci) EXE PRE	
26.7	8.5	(Clears memory)	
35.1	5.2	6.9 SHIFT ▷ 21.4 F1 (DT)	6.9
		12.9 SHIFT ▷ 15.7 F1 (DT)	12.9
		19.8 SHIFT ▷ 12.1 F1 (DT)	19.8
		26.7 SHIFT ▷ 8.5 F1 (DT)	26.7
		35.1 SHIFT ▷ 5.2 F1 (DT)	35.1
		(Constant term A)	
		F6 (REG) F1 (A) EXE	30.49758743
		(Regression coefficient B)	
		F2 (B) EXE	-0.04920370831
		(Correlation coefficient r) F3 (r) EXE	-0.997247352
		(\hat{y} when $xi = 16$) 16 F5 (\hat{y}) EXE	13.87915739
		(\hat{x} when $yi = 20$) 20 F4 (\hat{x}) EXE	8.574868046

The data in the above table can be used to obtain the terms of the regression formula and the correlation coefficient. Based on the regression formula, estimated value \hat{y} can be obtained for $xi = 16$, and estimated value \hat{x} can be obtained for $yi = 20$.

Chapter

5

Graphing

- 5-1 About the Graphing Function
- 5-2 Rectangular Coordinate Graphs
- 5-3 Polar Coordinate Graphs
- 5-4 Parametric Graphs
- 5-5 Inequality Graphs
- 5-6 Integration Graphs
- 5-7 Probability Distribution Graphs
- 5-8 Single-Variable Statistical Graphs
- 5-9 Paired-Variable Statistical Graphs
- 5-10 Other Graph Functions
- 5-11 Some Graphing Examples

■ Power Regression

- The power regression formula is $y = A \cdot x^B$ ($\ln y = \ln A + B \ln x$).
- Σx is obtained as $\Sigma \ln x$, Σx^2 as $\Sigma (\ln x)^2$, Σy as $\Sigma \ln y$, Σy^2 as $\Sigma (\ln y)^2$, and Σxy as $\Sigma \ln x \cdot \ln y$.

Example		Operation	Display
<i>xi</i>	<i>yi</i>	MODE 7 (REG) MODE 7 (PWR) MODE SHIFT 2 (Stat data: NON-)	
28	2410	SHIFT CLR F2 (Sci) EXE PRE (Clears memory)	
30	3033	28 SHIFT ▷ 2410 F1 (DT)	3.33220451
33	3895	30 SHIFT ▷ 3033 F1 (DT)	3.401197382
35	4491	33 SHIFT ▷ 3895 F1 (DT)	3.496507561
38	5717	35 SHIFT ▷ 4491 F1 (DT)	3.555348061
		38 SHIFT ▷ 5717 F1 (DT)	3.63758616
		(Constant term A) F6 (REG) F1 (A) EXE	0.2388010724
		(Regression coefficient B) F2 (B) EXE	2.771866153
		(Correlation coefficient <i>r</i>) F3 (r) EXE	0.9989062542
		(\hat{y} when $xi = 40$) 40 F5 (\hat{y}) EXE	6587.67458
		(\hat{x} when $yi = 1000$) 1000 F4 (\hat{x}) EXE	20.2622568

The data in the above table can be used to obtain the terms of the regression formula and the correlation coefficient. Based on the regression formula, estimated value \hat{y} can be obtained for $xi = 40$, and estimated value \hat{x} can be obtained for $yi = 1000$.

Chapter 5

Graphing

This chapter explains everything you need to know to fully use the versatile graphing capabilities of the unit.

5-1 About the Graphing Function

The large 96 × 64 dot display of the unit provides you with the capability to graph the following:

- Rectangular coordinates
- Polar coordinates
- Parametrics
- Inequalities
- Integrations
- Probability distributions
- Single-variable statistics
- Paired-variable statistics

These graphs can be produced using manual input or by programs.

■ Specifying the Range of a Graph

Before you draw a graph, you must first use the Range Parameter Screen to specify the range parameters of the graph.

• To display the Range Parameter Screen

Rectangular Coordinate Range Screen

<p>Range</p> <p>Xmin — minimum value of x-coordinate</p> <p>Xmax — maximum value of x-coordinate</p> <p>Xscl — scale of x-coordinate</p> <p>Ymin — minimum value of y-coordinate</p> <p>Ymax — maximum value of y-coordinate</p> <p>Yscl — scale of y-coordinate</p>	<pre> Range Xmin : -5. max : 5. scl : 2. Ymin : -10. max : 10. scl : 5. INIT </pre>
---	--

Polar Coordinate Range Screen

<p>Range</p> <p>T, θ min — minimum value of T/θ</p> <p>T, θ max — maximum value of T/θ</p> <p>T, θ pitch — pitch of T/θ</p>	<pre> Range T, θ min : 0. max : 360. ptch : 3.6 INIT </pre>
--	--

• To specify range parameters

Example To specify the following range parameters

Xmin	0
Xmax	5
Xscl	1
Ymin	-5
Ymax	15
Yscl	5
T, θ min	0
T, θ max	4π
T, θ ptch	$\pi \div 36$

0 **EXE**

Range
Xmin:0
max:5.
scl:2.
Ymin:-10.
max:10.
scl:5.
INIT

EXE

Range
Xmin:0
max:5.
scl:2.
Ymin:-10.
max:10.
scl:5.
INIT

1 [EXE]

```

Range
Xmin:0
max:5.
scl:1
Ymin:-10.
max:10.
scl:5.
INIT

```

▶ 5 [EXE]

```

Range
Xmin:0
max:5.
scl:1
Ymin:-5
max:10.
scl:5.
INIT

```

▶ 5 [EXE]

```

Range
Xmin:0
max:5.
scl:1
Ymin:-5
max:15
scl:5.
INIT

```

[EXE]

```

Range
T, θ
min:0.
max:360.
ptch:3.6
INIT

```

[EXE]

```

Range
T, θ
min:0.
max:360.
ptch:3.6
INIT

```

4 [SHIFT] [π] [EXE]

```

Range
T, θ
min:0.
max:4π
ptch:3.6
INIT

```

[SHIFT] [π] [÷] 3 6

```

Range
T, θ
min:0.
max:4π
ptch:π÷36_
INIT

```

Now if you press [EXE], the Range Parameter Screen is cleared. Press [Range] to confirm that your parameters are correct.

[Range]

```

Range
Xmin:0.
max:5.
scl:1.
Ymin:-5.
max:15.
scl:5.
INIT

```

[Range]

```

Range
T, θ
min:0.
max:12.5663706
ptch:0.087266462
INIT

```

Note that the π and division operations we entered above have been automatically converted to the correct values.

*You can set range parameters within the range of $-9.99999E+97$ to $9.99999E+97$.

*Input values can have up to nine significant digits. Values less than 10^{-2} and greater than 10^7 are displayed with a 6-digit mantissa (including sign) and a 2-digit exponent.

*The only input that is valid for range parameter input are numbers from 0 through 9, decimal points, EXP, (-), ◀, ▶, ▲, ▼, +, -, ×, ÷ and π . Note that negative values are indicated using ◀ or ▼.

- *You cannot specify 0 for Xscl or Yscl.
- *Do not specify the same value for the minimum and maximum.
- *If you input an illegal value, the previous parameter is retained without change.
- *If a minimum is greater than a maximum parameter, the axis is inverted.

Example Xmin :5
Xmax : -5

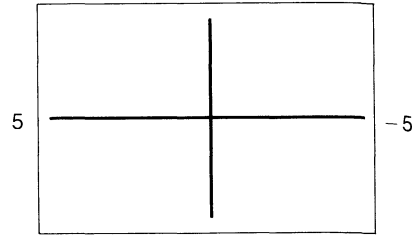

*Note that when you press **EXE** to input a parameter, anything that was previously located to the right of the cursor position is not input.

Example

```
Range
Xmin:=-25.
max:25.
```



```
Range
Xmin:=-25.
max:25.
```

3

```
Range
Xmin:=-35.
max:25.
```

EXE

```
Range
Xmin:-3
max:25.
```

- *You can input range parameters as expressions (such as 2π).
- *When a range setting that does not allow display of the axes is used, the scale for the y -axis is indicated on either the left or right edge of the display, while that for the x -axis is indicated on either the top or bottom edge.
- *When range values are changed, the graph display is cleared and the newly set axes only are displayed.
- *Range setting may cause irregular scale spacing.
- *If the range is set too wide, the graph produced may not fit on the display.
- *The point of deflection sometimes exceeds the capabilities of the display with graphs that change drastically as they approach the point of deflection.
- *A range that is too small can cause an Ma ERROR.

• To initialize the Range Parameter Screen settings

Range **F1** (INIT)

Anytime you perform the above operation, the unit initializes the range parameters to the following settings.

```
Range
Xmin:=-4.7
max:4.7
scl:1.
Ymin:=-3.1
max:3.1
scl:1.
INIT
```

```
Range
T,  $\theta$ 
min:0.
max:360.
ptch:3.6
INIT
```

→ { Rad max = 6.2831853
ptch = 0.062831853
Gra max = 400
ptch = 4

• To specify range parameters within a program

Use the following format to specify range parameters in a program.

Range (value of Xmin), (value of Xmax), (value of Xscl),
(value of Ymin), (value of Ymax), (value of Yscl),
(value of T, θ min), (value of T, θ max), (value of T, θ ptch)

5-2 Rectangular Coordinate Graphs

When drawing rectangular coordinate graphs, remember that the unit uses value memories X and Y to store values. Do not use these memories for storage if you plan to draw rectangular coordinate graphs.

■ Graphing Built-in Scientific Functions

Use the RUN/COMP Mode to draw rectangular coordinate graphs. Do not use the BASE-N Mode. When you graph a built-in function, the range parameters are set by the unit automatically.

● To check the current mode

[M] **[Disp]**

● To enter the correct mode

[MODE]

[1] (RUN)

[MODE]

[+] (COMP)

[MODE] **[SHIFT]** **[+]** (REC)

RUN / COMP
G-type : REC/CON

The following is a list of the built-in scientific functions that you can graph.

•sin	•cos	•tan	•sin ⁻¹	•cos ⁻¹	•tan ⁻¹
•sinh	•cosh	•tanh	•sinh ⁻¹	•cosh ⁻¹	•tanh ⁻¹
•√	•x ²	•log	•ln	•10 ^x	•e ^x
•x ⁻¹	•√				

● To graph the sine function

[Graph] **[sin]** **[EXE]**

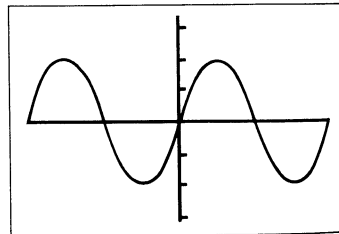

● To graph the $y = 1/x$ function

[Graph] **[SHIFT]** **[x⁻¹]** **[EXE]**

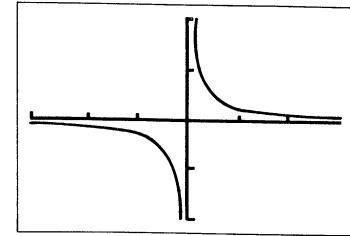

■ Overdrawing Built-in Function Graphs

You can draw two or more built-in function graphs on the same screen. The first graph is set automatically, and the same range is applied for subsequent graphs. The important thing to note in the following example is the use of **[X,θ,T]**. By pressing **[X,θ,T]** before **[EXE]** to graph the second function, you are telling the unit to leave the previously drawn graphs on the display. If you do not press **[X,θ,T]**, the unit will clear the graphic display automatically and graph only the last function you entered.

● To overdraw graphs

Example To graph $y = \sinh x$ and overdraw it with $y = \cosh x$

[Graph] **[SHIFT]** **[MATH]** **[F1]** (HYP)

[F1] (sinh) **[EXE]**

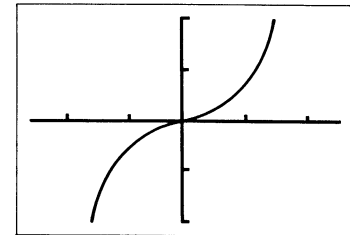

[Graph] **[F2]** (csh) **[X,θ,T]** **[EXE]**

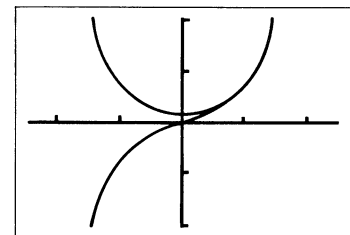

Note)

You cannot use built-in function graphs in multistatements (page 29) and programming (page 166).

■ Graphing Manually Entered Functions

You can graph manually entered functions by simply pressing $\boxed{\text{Graph}}$ and then entering the function. Remember that you also have to specify range parameters (page 113).

• To graph a manually entered function

Example To graph $y = 2x^2 + 3x - 4$ using the following range parameters

```
Range
Xmin:-5.
max:5.
scl:2.
Ymin:-10.
max:10.
scl:5.
INIT
```

$\boxed{\text{Graph}}$ $\boxed{2}$ $\boxed{\text{X},\theta,\text{T}}$ $\boxed{\text{SHIFT}}$ $\boxed{x^2}$ $\boxed{+}$ $\boxed{3}$ $\boxed{\text{X},\theta,\text{T}}$ $\boxed{-}$
 $\boxed{4}$ $\boxed{\text{EXE}}$

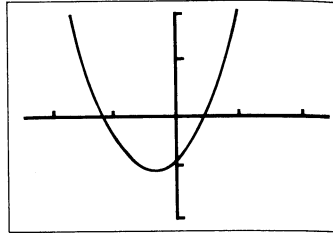

■ Overdrawing Manually Input Graphs

You can draw two or more built-in function graphs on the same screen. This makes it possible to find points of intersection and solutions at a glance.

Again note the use of $\boxed{\text{X},\theta,\text{T}}$ before $\boxed{\text{EXE}}$ when graphing the second function. If you do not press $\boxed{\text{X},\theta,\text{T}}$, the unit will clear the graphic display automatically and graph only the last function you entered

*You can also input value memory name X by pressing $\boxed{\text{ALPHA}}$ $\boxed{\text{X}}$.

• To overdraw manually entered graphs

Example To graph $y = 2x^2 + 3x - 4$ and overdraw it with $y = 2x + 3$

$\boxed{\text{SHIFT}}$ $\boxed{\text{F5}}$ $\boxed{\text{(C|s)}}$ $\boxed{\text{EXE}}$
 $\boxed{\text{Graph}}$ $\boxed{2}$ $\boxed{\text{X},\theta,\text{T}}$ $\boxed{\text{SHIFT}}$ $\boxed{x^2}$ $\boxed{+}$ $\boxed{3}$ $\boxed{\text{X},\theta,\text{T}}$ $\boxed{-}$
 $\boxed{4}$ $\boxed{\text{EXE}}$

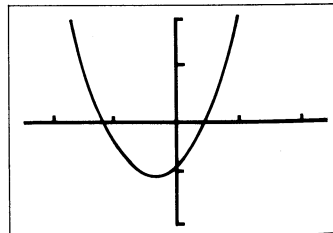

$\boxed{\text{Graph}}$ $\boxed{2}$ $\boxed{\text{X},\theta,\text{T}}$ $\boxed{+}$ $\boxed{3}$ $\boxed{\text{EXE}}$

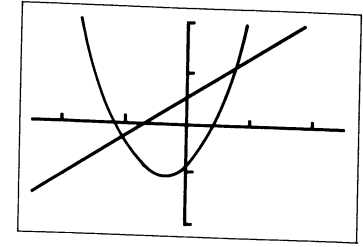

Later you will learn how to use the Trace Function (page 138) to find out the values at the points of intersection.

■ Specifying the Value Range

When graphing a function with the format “y = function”, you can specify the maximum and minimum values to be applied. Use the following format.

Graph y = [x function], [Xmin, Xmax]

Example To graph $y = x^2 + 3x - 5$ for the range $-2 \leq x \leq 4$

```
Range
Xmin:-3.
max:5.
scl:1.
Ymin:-10.
max:30.
scl:5.
INIT
```

$\boxed{\text{Graph}}$ $\boxed{\text{X},\theta,\text{T}}$ $\boxed{\text{SHIFT}}$ $\boxed{x^2}$ $\boxed{+}$ $\boxed{3}$ $\boxed{\text{X},\theta,\text{T}}$ $\boxed{-}$ $\boxed{5}$
 $\boxed{\text{SHIFT}}$ $\boxed{\text{>}}$ $\boxed{\text{ALPHA}}$ $\boxed{\text{[]}}$ $\boxed{-}$ $\boxed{2}$ $\boxed{\text{SHIFT}}$ $\boxed{\text{>}}$ $\boxed{4}$
 $\boxed{\text{ALPHA}}$ $\boxed{\text{[]}}$ $\boxed{\text{EXE}}$

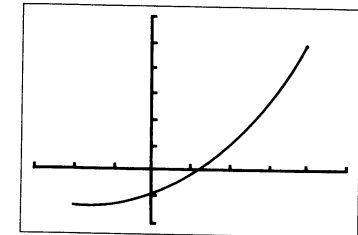

5-3 Polar Coordinate Graphs

You can use the unit to draw polar coordinate graphs after you change from the REC Mode to the POL Mode. When you graph a built-in function, the range parameters are set by the unit automatically. The functions that can be graphed in the POL Mode are those that fit the following format:

$$r = f(\theta)$$

Note that you should specify **rads** as the unit of angular measurement when graphing polar coordinate graphs. When drawing polar coordinate graphs, remember that the unit uses value memories r and θ to store values. Do not use these memories for storage if you plan to draw rectangular coordinate graphs.

• To check the current mode

[M] [Disp]

• To enter the correct mode

[SHIFT] [DRG] (Rad) [EXE]

[MODE] [2] (RUN)

[MODE] [SHIFT] [2] (POL)

RUN / COMP
G-type : POL/CON
angle : Rad

The following is a list of the built-in scientific functions that you can graph using polar coordinates.

$\sin\theta$	$\cos\theta$	$\tan\theta$	$\sin^{-1}\theta$	$\cos^{-1}\theta$	$\tan^{-1}\theta$
$\sinh\theta$	$\cosh\theta$	$\tanh\theta$	$\sinh^{-1}\theta$	$\cosh^{-1}\theta$	$\tanh^{-1}\theta$
$\sqrt{\theta}$	θ^2	$\log\theta$	10^θ	$\ln\theta$	e^θ
				$\sqrt[3]{\theta}$	θ^{-1}

Example 1 To graph $\tanh\theta$

[Graph] [SHIFT] [MATH] [F1] (HYP) [F3] (tnh) [EXE]

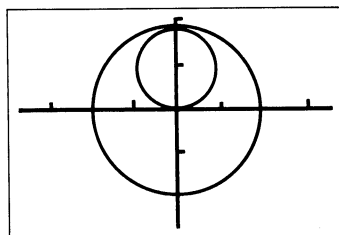

Example 2 To graph $\ln\theta$

[Graph] [ln] [EXE]

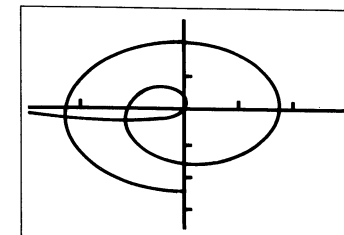

■ Graphing Manually Entered Functions

You can graph manually entered functions by simply pressing **[Graph]** and then entering the function. Manually entered functions must have the following format:

Graph $r = [\theta \text{ function}]$

Remember that you also have to specify range parameters (page 113).

• To graph a manually entered function

Example To graph $r = 2\sin 3\theta$ using the following range parameters

[Range]

[←] [3] [EXE] [3] [EXE] [1] [EXE]

[←] [2] [EXE] [2] [EXE] [1]

```

Range
Xmin:-3
max:3
scl:1
Ymin:-2
max:2
scl:1_
[INIT]
    
```

[EXE]

[0] [EXE]

[SHIFT] [π] [EXE]

[SHIFT] [π] [2] [3] [6]

[EXE]

```

Range
T, θ
min:0
max:π
ptch:π÷36_
[INIT]
    
```

Graph 2 sin 3 X,θ,T EXE

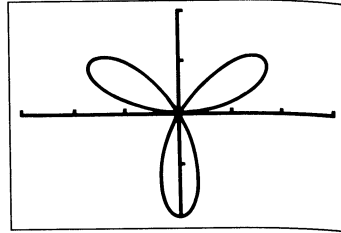

Important

If the difference between the minimum and maximum values you set for the pitch of T or θ is too great, your graph will be too rough. If the difference is too small, drawing of the graph will take a very long time.

■ Specifying the Value Range

When graphing a polar coordinate function, you can specify the maximum and minimum values to be applied. Use the following format.

Graph $r = [\theta \text{ function}], [\theta \text{min}, \theta \text{max}]$

Example To graph $r = 4 \sin \theta \cos \theta$ for the range $-\pi \leq \theta \leq \pi$

SHIFT F5 (Cls) EXE
 Graph 4 sin X,θ,T cos X,θ,T SHIFT ▸
 ALPHA [] SHIFT π SHIFT ▸ SHIFT π
 ALPHA [] EXE

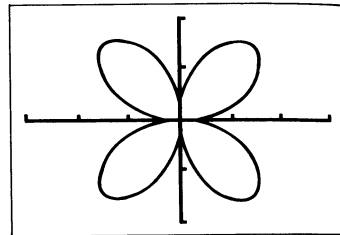

5-4 Parametric Graphs

To draw parametric graphs, first change to the PARAM Mode. The functions that can be graphed in the PARAM mode are those that fit the following format:

$$(X, Y) = (f(T), g(T))$$

When drawing parametric graphs, remember that the unit uses value memories X , Y and T to store values. Do not use these memories for storage if you plan to draw rectangular coordinate graphs.

- To check the current mode

MODE/Disp

- To enter the correct mode

MODE SHIFT

X (PARAM)

```

RUN / COMP
G-type : PRM / CON
    
```

- To graph a parametric equation

Example To graph the following functions:

$$x = 7 \cos T - 2 \cos 3.5T$$

$$y = 7 \sin T - 2 \sin 3.5T$$

Use the following range parameters.

```

Range
Xmin: -18.
max: 18.
scl: 5.
Ymin: -12.
max: 12.
scl: 5.
INIT
    
```

```

Range
T, θ
min: 0.
max: 4π.
ptch: π ÷ 36
INIT
    
```

SHIFT DRG F2 (Rad) SHIFT ↵
 Graph 7 cos X.θ.T \leftarrow 2 cos 3 . 5
 X.θ.T SHIFT ↵ 7 sin X.θ.T \leftarrow 2 sin
 3 . 5 X.θ.T) EXE

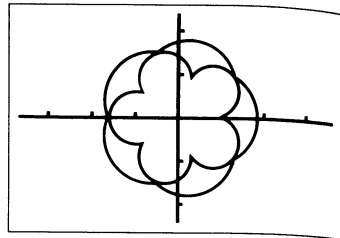

Important

If the difference between the minimum and maximum values you set for the pitch of T or θ is too great, your graph will be too rough. If the difference is too small, drawing of the graph will take a very long time.

■ Specifying the Value Range

When graphing a parametric function, you can specify the maximum and minimum values to be applied. Use the following format.

$$\text{Graph } (X, Y) = (f(T), g(T)), [Tmin, Tmax]$$

Example To graph the following functions:

$$x = 7\cos T - 2\cos 3.5T$$

$$y = 7\sin T - 2\sin 3.5T$$

Use the following range:

$$\pi \leq T \leq 2\pi$$

SHIFT F5 (Cls) EXE
 SHIFT DRG F2 (Rad) SHIFT ↵
 Graph 7 cos X.θ.T \leftarrow 2 cos 3 . 5
 X.θ.T SHIFT ↵ 7 sin X.θ.T \leftarrow 2 sin
 3 . 5 X.θ.T) SHIFT ↵ ALPHA []
 SHIFT π SHIFT ↵ 2 SHIFT π ALPHA []
 EXE

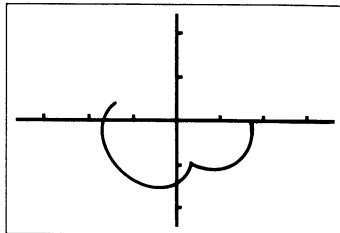

5-5 Inequality Graphs

To draw inequality graphs, first change to the INEQ Mode. The functions that can be graphed in the INEQ Mode are those that fit one of the following formats:

$$Y > f(x) \quad Y \geq f(x)$$

$$Y < f(x) \quad Y \leq f(x)$$

When drawing inequality graphs, remember that the unit uses value memories X and Y to store values. Do not use these memories for storage if you plan to draw rectangular coordinate graphs.

Important

Whenever drawing a new inequality graph, you should always start out with SHIFT F5 (Cls) EXE to clear the display.

● To check the current mode

MI Disp

● To enter the correct mode

MODE SHIFT

⊞ (INEQ)

RUN / COMP
G-type : INQ/CON

When you press the Graph key in the INEQ Mode, the following display appears.

$Y >$ $Y <$ $Y \geq$ $Y \leq$
 F1 F2 F3 F4

Use the function keys to input the inequality you are graphing.

Function Key	Inputs
F1	$Y >$
F2	$Y <$
F3	$Y \geq$
F4	$Y \leq$

• To graph an inequality

Example To graph $y < x^2 - 2x - 6$ using the following range parameters

```

Range
Xmin:-6.
max:6.
scl:1.
Ymin:-10.
max:10.
scl:5.
INIT
    
```

```

[SHIFT][F5](CIS)[EXE]
[Graph][F2](Y<)[X,θ,T][SHIFT][x²][=][2]
[X,θ,T][=][6][EXE]
    
```

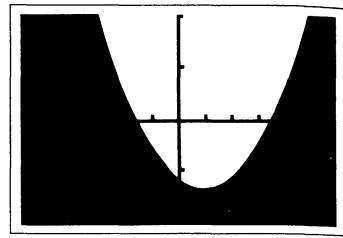

■ Overdrawing Inequality Graphs

If you draw two or more inequality function graphs on the same screen, the area containing values that satisfy both functions is filled in. In the following input sequence we will input two functions with a single operation. Note the [SHIFT][EXE] operation that separates the two functions.

• To overdraw inequality graphs

Example To graph $y > x^2 - 2x - 6$ and overdraw it with $y < -x^2 + 3x + 4$ using the following range parameters:

```

Range
Xmin:-6.
max:6.
scl:1.
Ymin:-10.
max:10.
scl:5.
INIT
    
```

```

[SHIFT][F5](CIS)[EXE]
[Graph][F1](Y>)[X,θ,T][SHIFT][x²][=][2]
[X,θ,T][=][6][SHIFT][↵]
[F2](Y<)[=][X,θ,T][SHIFT][x²][+][3]
[X,θ,T][+][4][EXE]
    
```

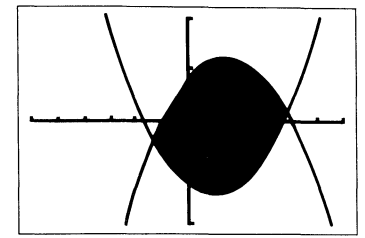
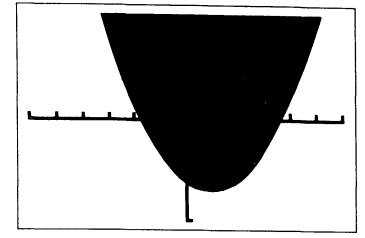

■ Specifying the Value Range

When drawing inequality graphs, you can specify the maximum and minimum values to be applied. Use one of the following formats.

- Graph $Y > f(x)$, [Xmin, Xmax] Graph $Y \geq f(x)$, [Xmin, Xmax]
- Graph $Y < f(x)$, [Xmin, Xmax] Graph $Y \leq f(x)$, [Xmin, Xmax]

Example To graph $y \leq 2x - 5$ using the range $0 \leq x \leq 2$, and the following range parameters:

```

Range
Xmin:-4.
max:4.
scl:1.
Ymin:-6.
max:2.
scl:1.
INIT
    
```

```

[SHIFT][F5](CIS)[EXE]
[Graph][F4](Y≤)[2][X,θ,T]
[=][5][SHIFT][▶][ALPHA][L]
[0][SHIFT][▶][2][ALPHA][J]
[EXE]
    
```

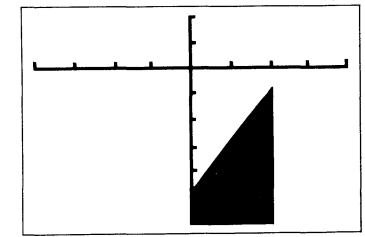

5-6 Integration Graphs

To draw integration graphs, you press SHIFT $\text{G-}\int dx$, enter the function, and then press EXE . The unit produces the graph on the display with the solution range painted in.

Important

Whenever drawing a new integration graph, you should always start out with SHIFT FS (CIs) EXE to clear the display.

• To graph an integral

Example To graph $\int_{-2}^1 (x+2)(x-1)(x-3) dx$ using the following range parameters:

```

Range
Xmin:-4.
max:4.
scl:1.
Ymin:-8.
max:12.
scl:5.
INIT
    
```

```

SHIFT FS (CIs) EXE
SHIFT G-∫dx ( X,θ,T ) (+) 2 ( X,θ,T )
(-) 1 ( X,θ,T ) (-) 3 ( )
SHIFT → (-) 2 SHIFT → 1 SHIFT →
5 EXE
    
```

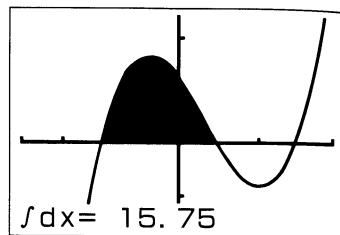

Note that you can also include the integral graph operation within programs.

5-7 Probability Distribution Graphs

The unit provides the ability to calculate the following four types of probability distributions (P, Q, R, t), and to produce three types of graphs (P, Q, R) of the distributions.

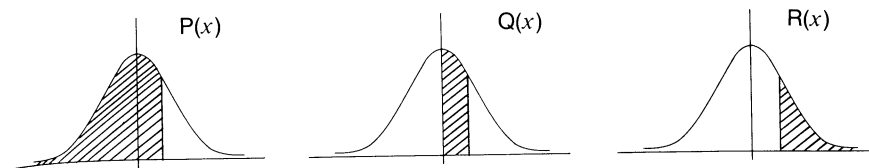

$$\frac{1}{\sqrt{2\pi}} \int_{-\infty}^x e^{-\frac{t^2}{2}} dt$$

$$\frac{1}{\sqrt{2\pi}} \int_0^x e^{-\frac{t^2}{2}} dt$$

$$\frac{1}{\sqrt{2\pi}} \int_0^{+\infty} e^{-\frac{t^2}{2}} dt$$

$t(x)$

$$t = \frac{x - \bar{x}}{\sigma n}$$

The unit automatically shades your graphs in accordance with the value for x , in $P(x)$, $Q(x)$, and $R(x)$.

To draw probability distribution graphs, the unit should be in the SD Mode and REC Mode.

*Note that you do not need to specify range parameters with probability distribution graphs.

• To check the current mode

IMDisp

• To enter the correct mode

MODE

\times (SD)

MODE SHIFT

$+$ (REC)

RUN / SD

G-type : REC/CON

When you press the $\boxed{F6}$ (PQR) key, the following display appears.

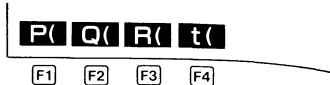

Use the function keys to input the probability distribution you are graphing.

Function Key	Inputs
$\boxed{F1}$	P(
$\boxed{F2}$	Q(
$\boxed{F3}$	R(
$\boxed{F4}$	t(

• To graph a probability distribution

Example To graph P(0.5)

$\boxed{\text{Graph}}$ $\boxed{F6}$ (PQR) $\boxed{F1}$ (P() $\boxed{0}$ $\boxed{\cdot}$ $\boxed{5}$
 $\boxed{\text{EXE}}$

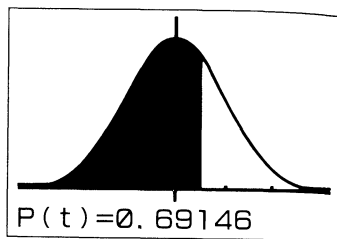

*The following shows the parameters that the unit uses for the probability distribution graph.

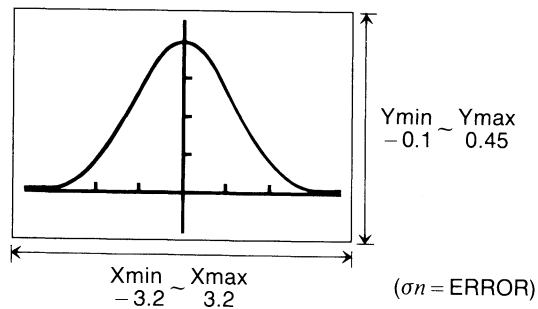

5-8 Single-Variable Statistical Graphs

To draw single-variable statistical graphs, you must use the **SD Mode** and the statistical graph **DRAW Mode**. The unit lets you draw bar graphs, line graphs and normal distribution curves using data you input.

• To check the current mode

$\boxed{\text{MDisp}}$

• To enter the correct mode

$\boxed{\text{MODE}}$

$\boxed{\times}$ (SD)

RUN / SD

$\boxed{\text{MODE}}$ $\boxed{\text{SHIFT}}$

$\boxed{3}$ (DRAW)

S-graph: DRAW

• To draw a bar graph

Example To draw a bar graph of the following data:

Rand	Value	Frequency
1	0	1
2	10	3
3	20	2
4	30	2
5	40	3
6	50	5
7	60	6
8	70	8
9	80	15
10	90	9
11	100	2

First, specify the range parameters. Since the maximum data value for x is 100, we will set X_{max} as 110. The maximum data value for y is 15, so set Y_{max} as 20.

```
Range
Xmin:0.
max:110.
scl:10.
Ymin:0.
max:20.
scl:2.
```

$\boxed{\text{INIT}}$

Next, specify the number of bars by increasing the number of value memories. Since we have 11 ranks, we should increase the number of memories by 11. If you skip this step, an error occurs when you try to draw the graph.

SHIFT **Defm** **1** **1** **EXE**

```

Program      : 0
F-Memory    : 0
Memory      : 39
Stat(SD)    : 0
Stat(REG)   : 0
Matrix      : 8
4076 Bytes Free
DT CL : DEV Σ PQR
    
```

Now clear the statistical memory.

SHIFT **CLR** **F2** (Sc) **EXE**

Input the data. For full details on the techniques you can use to input statistical data, see page 91.

PRE **0** **F1** (DT) **10** **F1** (DT) **F1** (DT) **F1** (DT) **20** **F1** (DT) **F1** (DT) **30** **F1** (DT)
F1 (DT) **40** **F1** (DT) **F1** (DT) **F1** (DT)
50 **F3** (;) **5** **F1** (DT) **60** **F3** (;) **6** **F1** (DT) **70** **F3** (;) **8** **F1** (DT)
80 **F3** (;) **15** **F1** (DT) **90** **F3** (;) **9** **F1** (DT) **100** **F1** (DT) **F1** (DT)

Now draw the graph.

Graph **EXE**

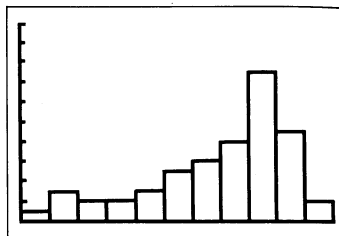

• To superimpose a line graph on a bar graph

While a bar graph is displayed, perform the following key operation.

Graph **SHIFT** **F4** (Line) **EXE**

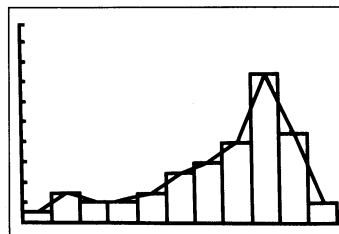

• To draw a normal distribution curve

Example Using the data input above, with the following range parameters:

```

Range
Xmin: 0.
max: 110.
scl: 10.
Ymin: 0.
max: 0.05
scl: 0.01
INIT
    
```

This change in range parameters is necessary because the y values are so much smaller than the x values.

Draw the graph.

Graph **SHIFT** **F4** (Line) **1** **EXE**

Inputting the number 1 causes a normal distribution curve to be drawn.

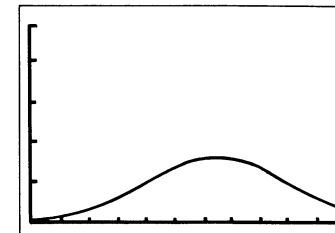

Notes

- *Be sure to expand the number of value memories to match the number of bars in a bar graph.
- *If you change the number of value memories while you are inputting data, you will not be able to draw a graph correctly.
- *If you input a value that is outside the minimum and maximum ranges you specify for the range parameters, the data is stored in statistical memory but not in graph memory.
- *If you input data that is greater than the maximum you specify for the y -axis, the bar is drawn to the upper limit of the display, and the points outside the range cannot be connected.
- *The following is the formula the unit uses to draw the normal distribution curve.

$$y = \frac{1}{\sqrt{2\pi}x\sigma n} e^{-\frac{(x-\bar{x})^2}{2x\sigma n^2}}$$

- *For range parameter settings, Xmin must be less than Xmax.
- *The message "done" appears on the display to indicate that drawing of a bar or line graph is complete.

5-9 Paired-Variable Statistical Graphs

To draw paired-variable statistical graphs, you must use the **REG** Mode and the statistical graph **DRAW** Mode. The unit draws graphs using data you input.

• To check the current mode

[M] Disp

• To enter the correct mode

MODE **[$\frac{1}{2}$]** (REG) **MODE** **[4]** (LIN)

RUN / LIN-REG

MODE **[SHIFT]**

[3] (DRAW)

S-graph: DRAW

• To draw a paired-variable graph

Example To draw a graph of the following data:

x_i	y_i
-9	-2
-5	-1
-3	2
1	3
4	5
7	8

First, specify the range parameters as shown below.

Range
 Xmin:-10.
 max:10.
 scl:2.
 Ymin:-5.
 max:15.
 scl:5.
INIT

Now clear the statistical memory.

[SHIFT] [CLR] [F2] (Scl) [EXE]

Input the data. For full details on the techniques you can use to input statistical data, see page 98.

PRE

DT CL : DEV Σ REG
[F1]

[SHIFT] [←] [9] [SHIFT] [→] [SHIFT] [←] [2] [F1] (DT)

[SHIFT] [←] [5] [SHIFT] [→] [SHIFT] [←] [1] [F1] (DT)

[SHIFT] [←] [3] [SHIFT] [→] [2] [F1] (DT)

[1] [SHIFT] [→] [3] [F1] (DT)

[4] [SHIFT] [→] [5] [F1] (DT)

[7] [SHIFT] [→] [8] [F1] (DT)

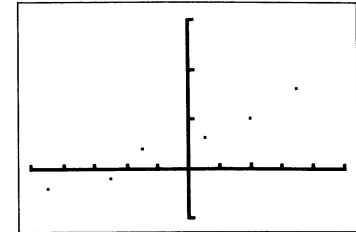

Now draw the graph.

MODE **[SHIFT] [+]** (REC)

Graph **[SHIFT] [F4] (Line) [1] [EXE]**

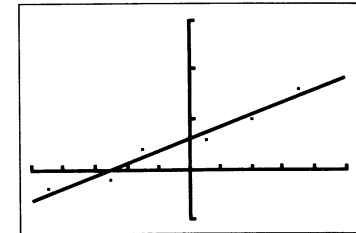

Notes

*A point is not plotted if a set of data is outside the range parameter values you specify.

*The following key operation causes an error (Ma ERROR) if no paired-variable statistical data is present in memory.

Graph **[SHIFT] [F4] (Line) [1] [EXE]**

*For range parameter settings, Xmin must be less than Xmax.

5-10 Other Graph Functions

The functions described in this section can be used with rectangular coordinate, polar coordinate, parametric, inequality, and statistical graphs.

■ Connect Type and Plot Type Graphs

If you select a connect type graph, the points that are plotted are connected by lines. With a plot type graph, the points are not connected.

• To select a graph type

MODE
SHIFT

Draw type
5:CONNECT
6:PLOT

Press **5** to select connect type or **6** to select plot type.

RUN / COMP	
G-type : REC/CON	Graph type
angle : Deg	CON = connect type PLT = plot type
display : Nrm1	

■ Trace Function

The Trace Function lets you move a pointer along the line in a graph and display coordinate values at any point. The following illustrations show how values are displayed for each type of graph.

• Rectangular Coordinate Graph

X=0.6684239 Y=0.6197498

• Polar Coordinate Graph

r=0.7880549 θ=2.1991148

• Parametric Graph

T=5.8826322
X=-0.389927 Y=0.9208454

• Inequality Graph

X=1.4705327 Y ≤ -0.675066

• To determine the values of points of intersection

Example To determine the values of the points of intersection for the following equations:

$$y = x^2 - 3$$

$$y = -x + 2$$

Use the following range parameters:

Range
Xmin: -5.
max: 5.
scl: 1.
Ymin: -10.
max: 10.
scl: 2.
INIT

Draw the graph of the first equation.

MODE SHIFT + (REC)
Graph X,θ,T SHIFT x² = 3 EXE

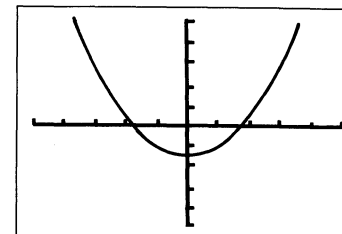

Overdraw the graph of the second equation.

Graph X,θ,T + 2 EXE

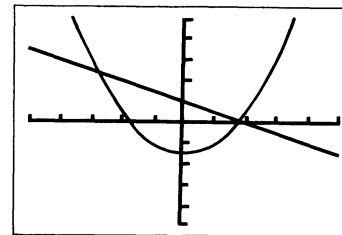

Press **F1** (Trace) to activate the Trace Function.

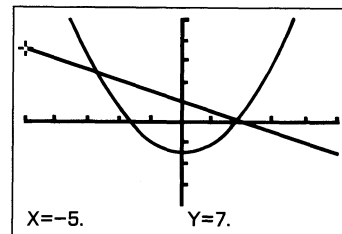

Move the pointer using \blacktriangleright and \blacktriangleleft . Holding down either key moves the pointer at high speed.

Move the pointer to the first intersection.

When the pointer is at the location you want, press $\boxed{F6}$ (Coord) to view coordinates individually. Each press of $\boxed{F6}$ changes the coordinate display in the following sequence:

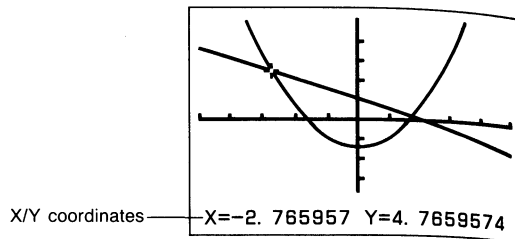

$\boxed{F6}$ (Coord)

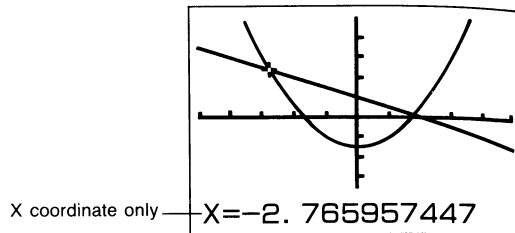

$\boxed{F6}$ (Coord)

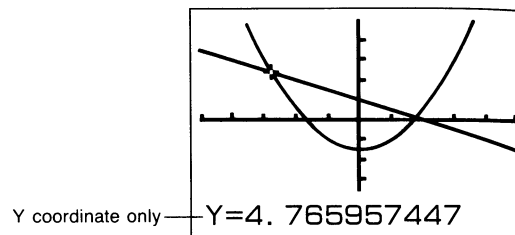

Important

The pointer does not move at fixed intervals. It follows the dots on the display. Because of this, the values provided for coordinates are approximate.

Move the pointer to the next intersection.

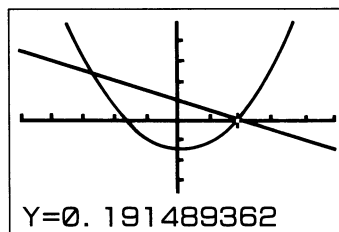

You can then use $\boxed{F6}$ (Coord) to view the x and y coordinate values.

$\boxed{F6}$ (Coord)

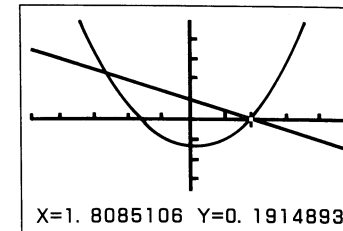

Finally, press $\boxed{F1}$ (Trace) again to exit the Trace Function.

• To move the trace between two graphs

Note

This operation can be used with up to six graphs that are overdrawn using multistatements or programming.

Example To trace points on the following equations (using a multistatement):

$$y = (x + 2)(x - 3)$$

$$y = 2x - 3$$

Use the following range parameters:

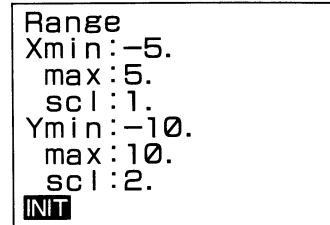

Execute the multistatement that draws the two graphs.

```
MODE SHIFT + (REC)
SHIFT F5 (CIs) EXE
Graph ( X,θ,T + 2 ) ( X,θ,T - 3 )
SHIFT PRGM F6 (: )
Graph 2 X,θ,T - 3
EXE
```

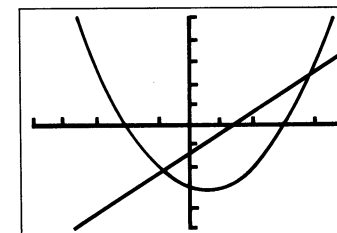

Press $\boxed{F1}$ (Trace) to activate the Trace Function. The pointer appears on the graph drawn by the last function in the multistatement.

$\boxed{F1}$ (Trace)

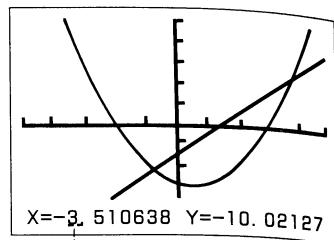

Pointer

Move the pointer along the line where it is located using \blacktriangleright and \blacktriangleleft . Holding down either key moves the pointer at high speed.

Use \blacktriangleup and \blacktriangledown to move the pointer between the two graphs.

\blacktriangledown (or \blacktriangleup)

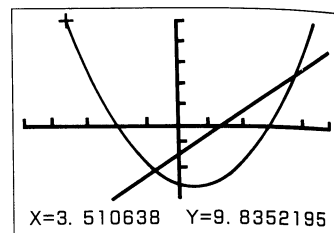

Note)

*If you have more than two graphs shown on the display, the \blacktriangleup and \blacktriangledown cursors can be used to move the pointer from graph to graph.

When you are finished, press $\boxed{F1}$ (Trace) again to exit the Trace Function.

■ Scrolling Graphs

If the graph you are tracing runs off the display to the left or right, the display scrolls automatically to follow the Trace Function pointer as you trace the graph.

Example

\boxed{SHIFT} \boxed{DRG} $\boxed{F1}$ (Deg) \boxed{EXE}

\boxed{Graph} \boxed{sin} \boxed{EXE}

$\boxed{F1}$ (Trace)
 $\blacktriangleright \sim \blacktriangleleft$

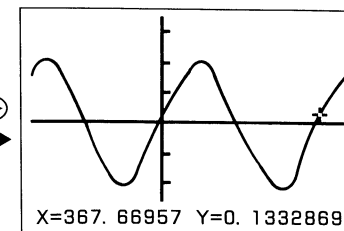
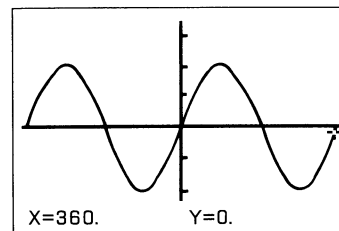

$\blacktriangleleft \sim \blacktriangleleft$ \downarrow

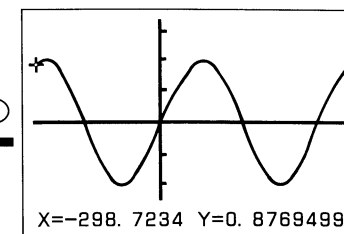
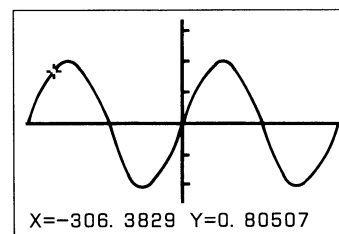

\blacktriangleleft

•If the graph you are tracing runs off the display to the top or bottom, the display does not scroll.

$\blacktriangleright \sim \blacktriangleright$

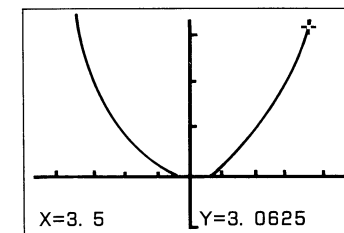

•You cannot scroll polar coordinate or parametric graphs. You also cannot scroll over-drawn graphs that contain polar coordinate or parametric graphs.

■ Notes on Using the Trace Function

- You can use the Trace Function immediately after you draw a graph only. If you draw a graph and then perform a calculation or any other operation (besides \boxed{M} -Disp, Range, or G-T), the Trace Function will be unavailable.
- The coordinate values at the bottom of the display are shown with a 10-digit mantissa, or with a 5-digit mantissa and 2-digit exponent. Negative values are one digit shorter because one digit is used for the negative sign.
- You cannot use the Trace Function during program execution.
- Once program execution is suspended by a "▲" symbol, you can use the Trace Function on an graph produced at that point.
- If you are drawing multiple graphs using multistatements, you can use the Trace Function to trace a graph that is displayed by a display result command (page 29). When you press \boxed{EXE} to resume drawing of the next graph, the Trace Function is automatically cancelled and the pointer disappears from the display.

Plot Function

The Plot Function makes it possible to plot points anywhere on a graph.

To plot a point on a graph

Example To plot a point at $x=2, y=2$, with the following range parameters:

```

Range
Xmin:-5.
max:5.
scl:1.
Ymin:-10.
max:10.
scl:2.
INIT
    
```

SHIFT **F5** (Cls) **EXE**
SHIFT **F3** (Plot) **2** **SHIFT** **↵** **2** **EXE**

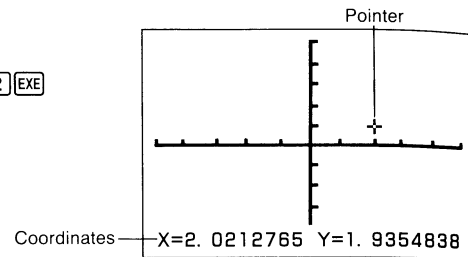

Move the pointer using **▶**, **◀**, **▲** and **▼**. Holding down these keys moves the pointer at high speed.

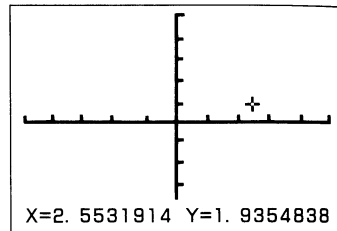

F6 (Coord)

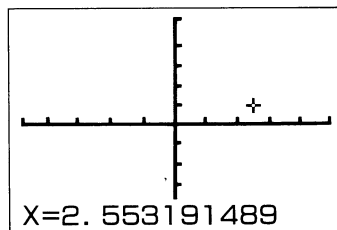

F6 (Coord)

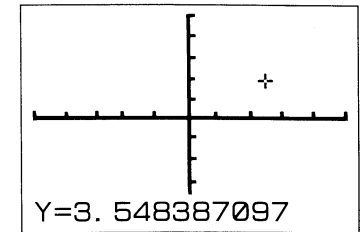
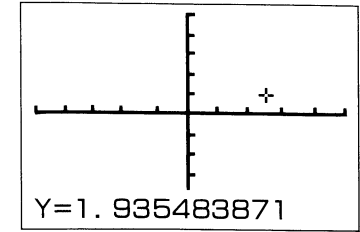

When the pointer is at the location you want, press **EXE** to plot a point. At this time, the pointer returns to the original point you specified (2, 2 in this example).

EXE

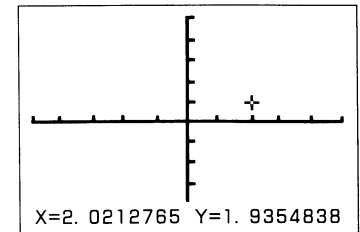

You can change the original point at any time by pressing **F3** (Plot) and inputting new coordinates.

F3 (Plot) **3** **◦** **5** **SHIFT** **↵** **6** **◦**
5 **EXE**

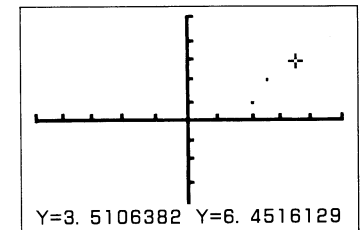

Note)

*In the above example, we specified a starting point of 2, 2. You can also enter the graph display to plot points by simply pressing **F3** (Plot) followed directly by **EXE**.

```

Range
Xmin:-2.
max:5.
scl:1.
Ymin:-2.
max:10.
scl:2.
INIT

```

SHIFT F3 (Plot) EXE

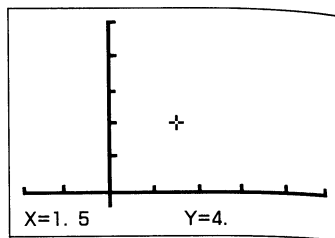

*If you specify a point that is outside the range set up by the range parameters, the pointer does not appear on the display.

*The x -coordinate value of the current pointer location is stored in the X value memory. The y -coordinate value is stored in the Y value memory.

Line Function

With the Line Function, you can link two points with a straight line.

To draw a line in a graph

Example To draw the graph for $y = 3x$, and then draw lines from the point on the graph where $x = 2$ and $y = 0$

Use the following range parameters:

```

Range
Xmin:-2.
max:5.
scl:1.
Ymin:-2.
max:10.
scl:2.
INIT

```

Draw the graph.

SHIFT F5 (Cls) EXE

Graph 3 (X,Y,T) EXE

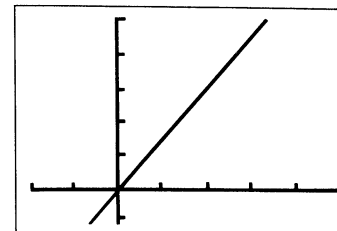

Use the Plot Function to locate the pointer at $x = 2, y = 0$.

F3 (Plot) 2 SHIFT 9 0 EXE

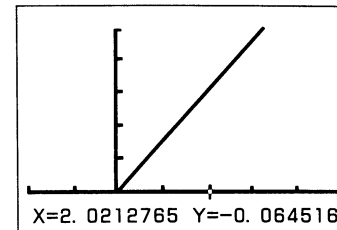

Move the pointer up to the graph line.

F3 (Plot) 2 SHIFT 9 0 EXE

▲ ~ ▲

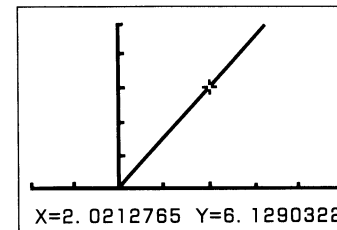

Draw the line.

F4 (Line) EXE

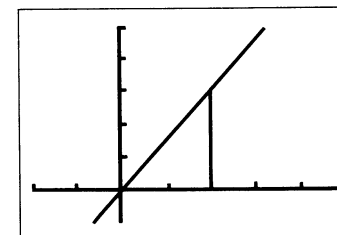

Now draw another line to the y -axis. Since the x - and y -coordinates of the point you last plotted are stored in X and Y value memories, you can easily move the pointer back to the point on the graph. Note the following operation.

$\boxed{F3}$ (Plot) $\boxed{\text{ALPHA}}$ \boxed{X} $\boxed{\text{SHIFT}}$ $\boxed{\blacktriangleright}$ $\boxed{\text{ALPHA}}$ \boxed{Y}
 $\boxed{\text{EXE}}$

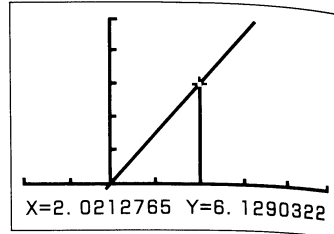

Move the pointer to the y -axis.

$\boxed{\blacktriangleleft}$ ~ $\boxed{\blacktriangleleft}$

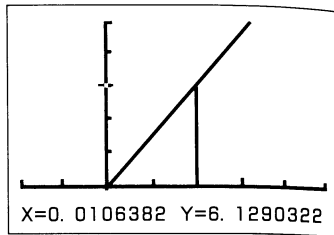

Draw the line.

$\boxed{F4}$ (Line) $\boxed{\text{EXE}}$

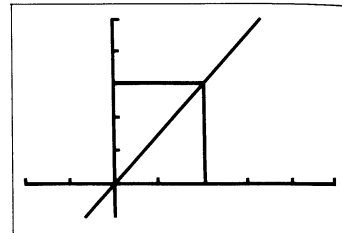

■ Graph Scroll Function

Immediately after you have drawn a graph, you can scroll it on the display. Use the cursor keys to scroll the graph left, right, up and down.

● To scroll the graph on the display

Example To draw the graph for $y = 0.25(x+2)(2x+1)(2x-5)$, $y = 2x - 3$, and then scroll it.

Use the following range parameters:

Range
 Xmin: -5.
 max: 5.
 scl: 1.
 Ymin: -8.
 max: 8.
 scl: 2.
INIT

$\boxed{\text{MODE}}$ $\boxed{\text{SHIFT}}$ $\boxed{+}$ (REC)
 $\boxed{\text{Graph}}$ $\boxed{0}$ $\boxed{\cdot}$ $\boxed{2}$ $\boxed{5}$ $\boxed{}$ $\boxed{X,\theta,T}$ $\boxed{+}$ $\boxed{2}$ $\boxed{}$
 $\boxed{}$ $\boxed{2}$ $\boxed{X,\theta,T}$ $\boxed{+}$ $\boxed{1}$ $\boxed{}$ $\boxed{}$ $\boxed{2}$ $\boxed{X,\theta,T}$ $\boxed{-}$
 $\boxed{5}$ $\boxed{}$ $\boxed{\text{SHIFT}}$ $\boxed{\blacktriangledown}$
 $\boxed{\text{Graph}}$ $\boxed{2}$ $\boxed{X,\theta,T}$ $\boxed{-}$ $\boxed{3}$ $\boxed{\text{EXE}}$

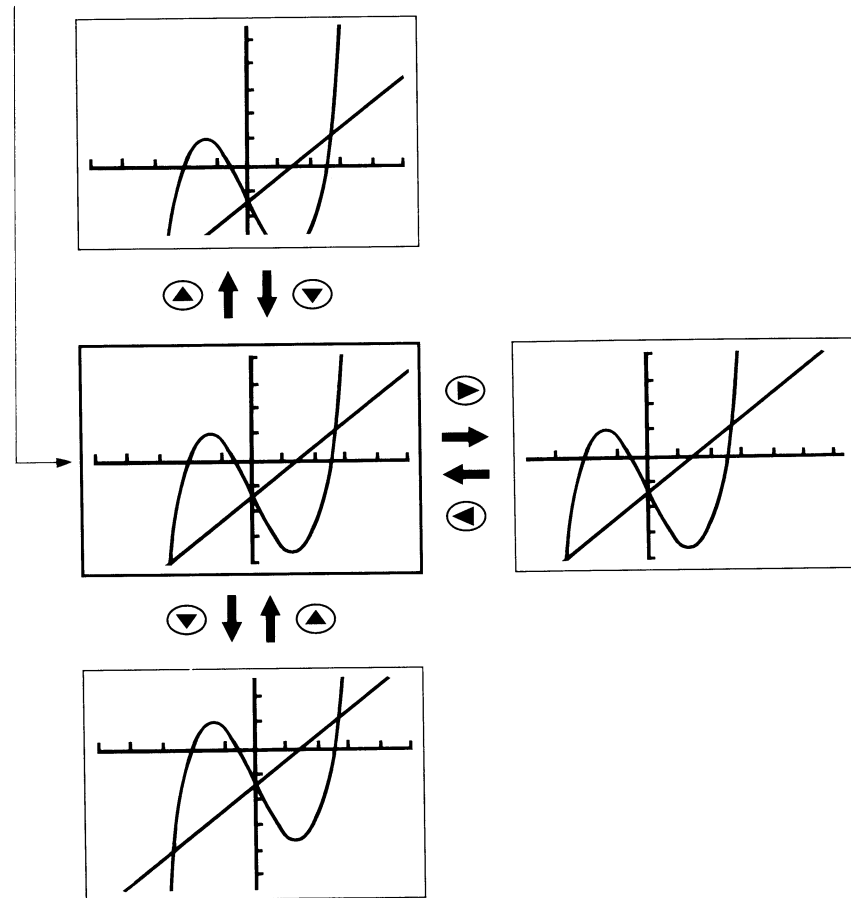

• You cannot scroll combination bar/line graphs.

Zoom Functions

The Enlarge and Reduce Functions let you zoom in and out on graphs.

To display the Zoom Menu

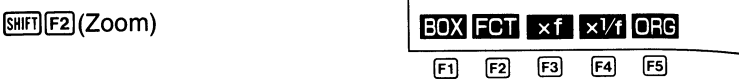

- The following are the operations that are available from the function display at the bottom of the screen. Press the function key below the operation you want to perform.
- F1** (BOX) Box Function
- F2** (FCT) Displays the factor input screen
- F3** ($\times f$) Zooms in or out on the graph in accordance with the zoom factors
- F4** ($\times 1/f$) Zooms in or out on the graph in accordance with the inverse of the zoom factors
- F5** (ORG) Returns zoomed graph to original dimensions

Box Function

The Box Function lets you cut out a specific section of a graph for zooming.

To zoom in on a part of a graph

Example To specify a box on the graph for $y = (x + 5)(x + 4)(x + 3)$, with the following range parameters:

Specify the range parameters.

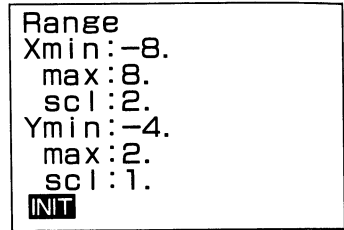

Draw the graph.

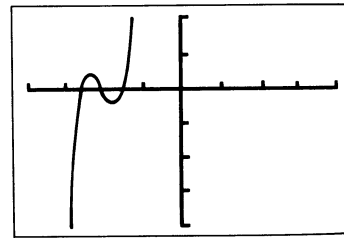
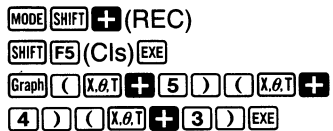

Press **F2** (Zoom) to activate the Zoom Function.

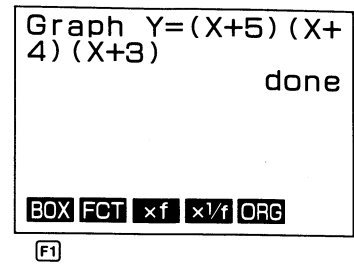

Press **F1** (BOX) to activate the Box Function.

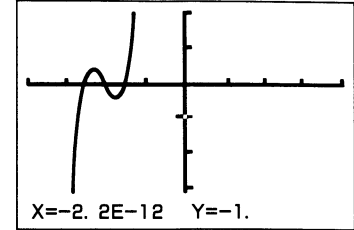

Move the pointer using the cursor keys. Holding down any of these keys moves the pointer at high speed.

Once the pointer is located where you want one corner of the box to be, press **EXE**.

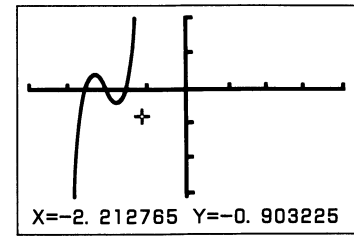

Move the pointer to the location of the corner diagonally opposite the one you have just set. Note that a box automatically appears on the display.

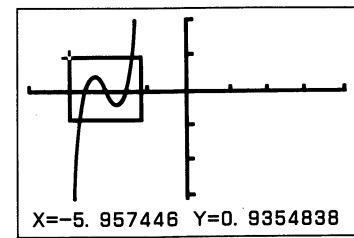

When the pointer is located where you want the other corner of the box to be, press **EXE**.

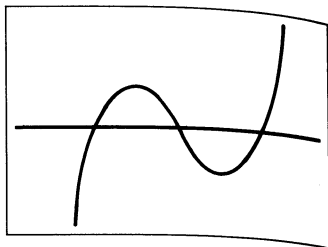

Note that the box you defined becomes the outline of the display, and the graph is enlarged to fit.

You can repeat the enlarge operation and make enlargements of part of an enlarged graph.

• To return a graph to its original size

Example To return to the graph enlarged above to its original size

F2(Zoom)**F5**(ORG)

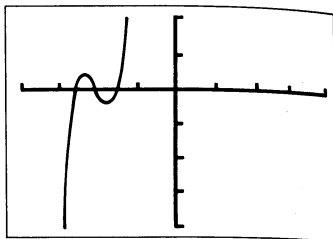

• If you locate the second corner of the box horizontally or vertically with the first corner, no box is formed, and so the graph is not enlarged.

■ Using the Factor Function to Enlarge and Reduce the Entire Graph

You can enlarge or reduce the entire graph. You can set different factors for the x and y -axes, which means that you can double the length while leaving the height unchanged, or vice versa.

With this function, you can also use the Plot Function or Box Function to select a point on the graph to be in the center of the enlarged or reduced graph. If you do not specify a point, the center of the normal size graph is used as the center of the enlarged or reduced graph.

• To enlarge a graph

Example To enlarge the graph for $y = \sin x$ by 1.5 times on the x -axis and 2 times on the y -axis, using the following range parameters:

Specify the range parameters.

```
Range
Xmin:-360.
max:360.
scl:180.
Ymin:-1.6
max:1.6
scl:0.5
INIT
```

Draw the graph.

MODE **SHIFT** **+** (REC)
SHIFT **DRG** **F1** (Deg) **EXE**
Graph **sin** **X,θ,T** **EXE**

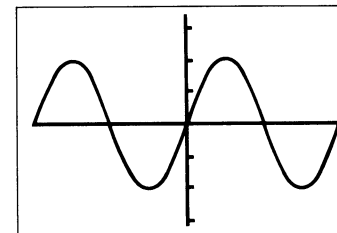

Press **F2**(Zoom) to display the Zoom Menu.

```
BOX FCT x/f x1/f ORG
F2
```

Press **F2**(FCT) again to display the Factor Input Screen.

```
Factor
Xfct:2.
Yfct:2.
INIT
```

Input the zoom factors for the x -axis and y -axis.

1 . 5 EXE

```
Factor
Xfct:1.5
Yfct:2.
```

2 . 0

```
Factor
Xfct:1.5
Yfct:2.0_
```

EXE

Press $\text{F3}(\times f)$ to redraw the graph according to the factors you have specified.

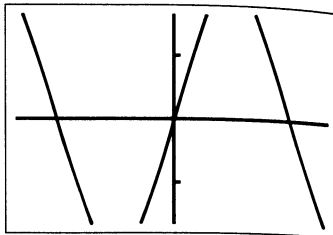

At this time, the range parameters are changed as follows:

Range

```
Range
Xmin:-240.
max:240.
scl:180.
Ymin:-0.8
max:0.8
scl:0.5
INIT
```

You can repeat the enlarge operation and enlarge the enlarged graph again.

• To reduce a graph

Example To reduce the graph for $y = \sin x$ by 1.5 times on the x -axis and 2.0 times on the y -axis, using the following range parameters:

Specify the range parameters.

```
Range
Xmin:-360.
max:360.
scl:180.
Ymin:-1.6
max:1.6
scl:0.5
INIT
```

Draw the graph.

MODE SHIFT + (REC)
SHIFT DRG F1 (Deg) EXE
Graph sin X.θ.T EXE

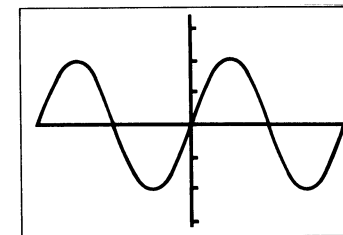

Press F2 (Zoom) to display the Zoom Menu.

BOX FCT $\times f$ $\times 1/f$ ORG
F2

Press F2 (FCT) again to display the Factor Input Screen.

```
Factor
Xfct:2.
Yfct:2.
```

Input the zoom factors for the x -axis and y -axis.

1 . 5 EXE

```
Factor
Xfct:1.5
Yfct:2.
```

2 . 0

```
Factor
Xfct:1.5
Yfct:2.0_
```

EXE

Press $\boxed{F4}$ ($\times 1/i$) to redraw the graph according to the factors you have specified.

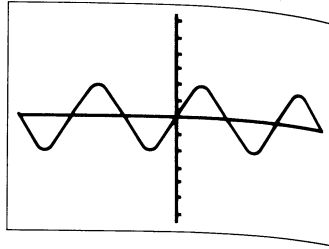

At this time, the range parameters are changed as follows:

```

Range
Xmin:-540.
max:540.
scl:180.
Ymin:-3.2
max:3.2
scl:0.5
INIT
    
```

You can repeat the reduce operation and reduce the reduced graph again.

• To redraw a graph using the inverse of the factors

Continuing from the graph reduction example above, press $\boxed{F2}$ (Zoom) and then $\boxed{F4}$ ($\times 1/i$).

$\boxed{\text{Range}} \boxed{\text{Range}}$
 $\boxed{F2}$ (Zoom) $\boxed{F4}$ ($\times 1/i$)

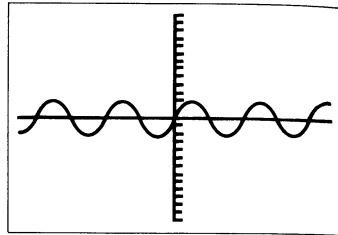

At this time, the range parameters are changed as follows:

$\boxed{\text{Range}}$

```

Range
Xmin:-810.
max:810.
scl:180.
Ymin:-6.4
max:6.4
scl:0.5
INIT
    
```

• To specify the center point of an enlarged display

Example To enlarge the graphs: $y = (x+4)(x+1)(x-3)$, and $y = 3x+22$ by 5 times on the x-axis and y-axis, with the apparent point of tangency at the center of the display. Use the following range parameters:

Specify the range parameters.

```

Range
Xmin:-8.
max:8.
scl:5.
Ymin:-30.
max:30.
scl:10.
INIT
    
```

Draw the graph.

$\boxed{\text{MODE}} \boxed{\text{SHIFT}} \boxed{+}$ (REC)
 $\boxed{\text{Graph}} \boxed{(\text{X},\theta,T)} \boxed{+} \boxed{4} \boxed{)}$ $\boxed{(\text{X},\theta,T)} \boxed{+}$
 $\boxed{1} \boxed{)}$ $\boxed{(\text{X},\theta,T)} \boxed{-} \boxed{3} \boxed{)}$ $\boxed{\text{SHIFT}} \boxed{\downarrow}$
 $\boxed{\text{Graph}} \boxed{3} \boxed{(\text{X},\theta,T)} \boxed{+} \boxed{2} \boxed{2} \boxed{\text{EXE}}$

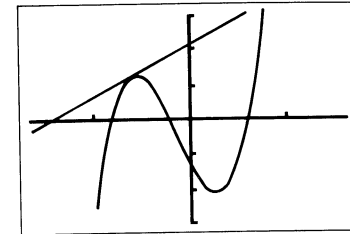

Press $\boxed{F1}$ (Trace).
 Use the cursor keys to move the pointer to the point of intersection.

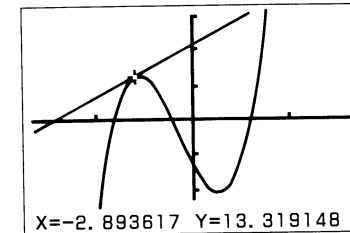

Press $\boxed{F2}$ (Zoom) to display the Zoom Menu.
 Press $\boxed{F2}$ (FCT) again to display the Factor Input Screen.

```

Factor
Xfct:1.5
Yfct:2.
    
```

Input the zoom factors for the x -axis and y -axis.

5 **EXE** **5**

```
Factor
Xfct:5
Yfct:5_
```

EXE

```
Graph Y=(X+4)(X+
1)(X-3)
Graph Y=3X+22
done
```

BOX **FCT** **xf** **x/1** **ORG**

F3

Press **F3** ($\times f$) to redraw the graph according to the factors you have specified.

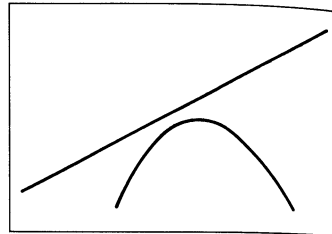

Note that these graphs are not tangent as they appear on the normal (unenlarged) display.

• To initialize the zoom factors

F2(Zoom) **F2**(FCT) **F1**(INIT)

Anytime you perform the above operation, the unit initializes the zoom factors to the following setting.

```
Factor
Xfct:2.
Yfct:2.

INIT
```

• To specify the zoom factors within a program

Use the following format to specify the zoom factors in a program.

Factor (Xfct), (Yfct)

5-11 Some Graphing Examples

The following examples are presented to show you some ways that the graphing functions can be used effectively.

Example 1 To graph the function $y = x^3 - 9x^2 + 27x + 50$

Use the following range parameters.

```

Range
Xmin:-5.
max:10.
scl:2.
Ymin:-30.
max:150.
scl:20.
INIT
    
```

```

MODE SHIFT + (REC)
SHIFT F5 (CIs) EXE
Graph X,θ,T x² 3 - 9 X,θ,T SHIFT x²
+ 2 7 X,θ,T + 5 0 EXE
    
```

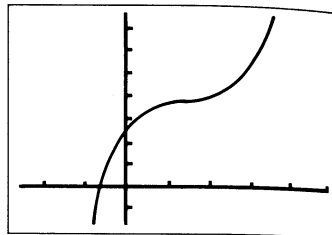

Example 2 To graph the function $y = x^6 + 4x^5 - 54x^4 - 160x^3 + 641x^2 + 828x - 1260$

Use the following range parameters.

```

Range
Xmin:-10.
max:10.
scl:2.
Ymin:-8000.
max:8000.
scl:2000.
INIT
    
```

```

SHIFT F5 (CIs) EXE
Graph X,θ,T x² 6 + 4 X,θ,T x² 5
- 5 4 X,θ,T x² 4 - 1 6 0
X,θ,T x² 3 + 6 4 1 X,θ,T SHIFT x²
+ 8 2 8 X,θ,T - 1 2 6 0 EXE
    
```

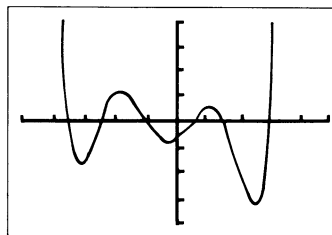

Example 3 To graph the function $y = x^4 + 4x^3 - 36x^2 - 160x + 300$ and determine its minimum and maximum

Use the following range parameters.

```

Range
Xmin:-10.
max:10.
scl:2.
Ymin:-600.
max:600.
scl:200.
INIT
    
```

```

SHIFT F5 (CIs) EXE
Graph X,θ,T x² 4 + 4 X,θ,T x² 3
- 3 6 X,θ,T SHIFT x² - 1 6 0
X,θ,T + 3 0 0 EXE
    
```

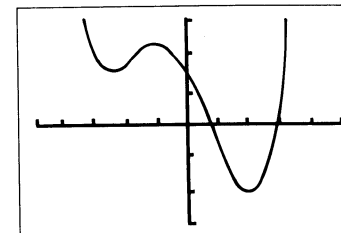

Example 4 To determine the points of tangency for the following functions:

$$y = x^3 - 3x^2 - 6x - 16$$

$$y = 3x - 11$$

Use the following range parameters.

```

Range
Xmin:-10.
max:10.
scl:2.
Ymin:-60.
max:40.
scl:10.
INIT
    
```

```

SHIFT F5 (CIs) EXE
Graph X,θ,T x² 3 - 3 X,θ,T SHIFT x²
- 6 X,θ,T - 1 6 SHIFT ↓
Graph 3 X,θ,T - 1 1 EXE
    
```

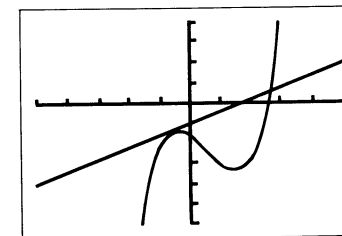

Example 5 To store $x^3 + 1$, $x^2 + x$ into Function Memory (page 57), and then graph:
 $y = x^3 + x^2 + x + 1$

Use the following range parameters:

```

Range
Xmin:-4.
max:4.
scl:1.
Ymin:-10.
max:10.
scl:1.
INIT
    
```

$\boxed{X.\theta.T} \boxed{x^3} \boxed{3} \boxed{+} \boxed{1} \boxed{SHIFT} \boxed{MEM} \boxed{F1} \boxed{(STO)} \boxed{1}$

\boxed{AC} (stores $(x^3 + 1)$)

$\boxed{X.\theta.T} \boxed{SHIFT} \boxed{x^2} \boxed{+} \boxed{X.\theta.T} \boxed{F1} \boxed{(STO)} \boxed{2}$

\boxed{AC} (stores $(x^2 + x)$)

$\boxed{Graph} \boxed{F3} \boxed{(fn)} \boxed{1} \boxed{+} \boxed{F3} \boxed{(fn)} \boxed{2} \boxed{EXE}$

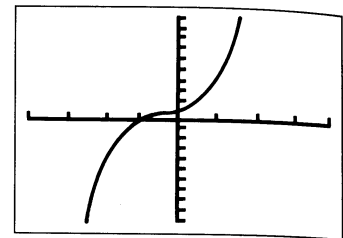

Chapter

6

Programming

- 6-1 Introduction to Programming
- 6-2 About Error Messages
- 6-3 Counting the Number of Steps
- 6-4 Program Commands
- 6-5 Using Jump Commands
- 6-6 Using Subroutines
- 6-7 Using Array Memory
- 6-8 Displaying Text Messages
- 6-9 Using the Graph Function in Programs

Chapter 6 **Programming**

This chapter tells you how to use the versatile program memory of the unit. Once you program a calculation, you can call it up and execute it using any values you want at the touch of a key.

6-1 Introduction to Programming

The following explains the basics about programming the unit. We also provide a number of actual easy-to-understand examples for your reference. For full details on each of the programming operations, see the other sections in this chapter.

■ To enter the Programming Mode

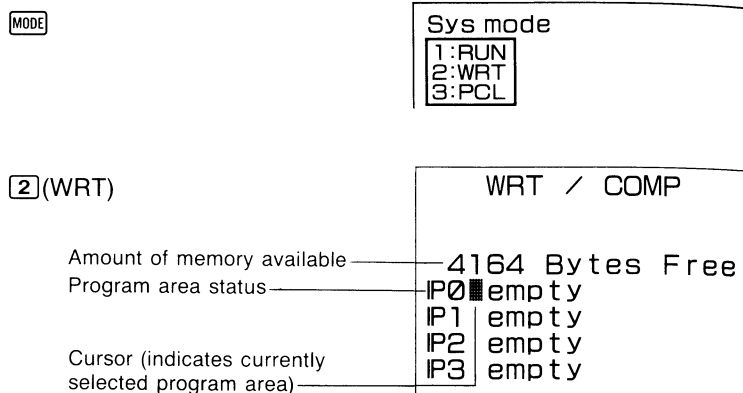

The above display shows that there is 4,164 bytes of memory available to store programs. Though you can see only four program area names, there are actually a total of 38, named P0 through P9, PA through PZ, Pr, and Pθ.

■ To scroll through program area names



```
4164 Bytes Free
IP1 empty
IP2 empty
IP3 empty
IP4 empty
```



```
4164 Bytes Free
IP0 empty
IP1 empty
IP2 empty
IP3 empty
```

To select a specific program area



```
4164 Bytes Free
IP5 empty
IP6 empty
IP7 empty
IP8 empty
```



```
4164 Bytes Free
IP5 empty
IPT empty
IPU empty
IPV empty
```

■ To check how much memory is used by a program

Move the cursor to the program area you want to check.

Hold down the **DIS** key.

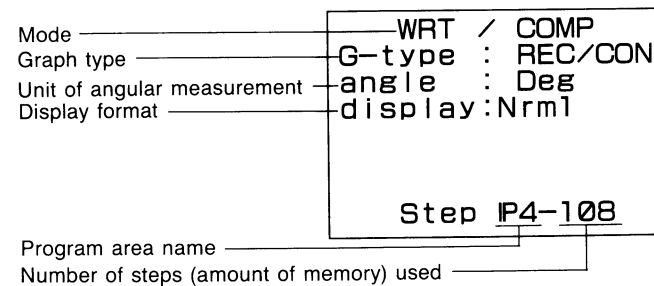

■ To input a program

Example To program the following formulas, which calculate the surface area (S) and volume (V) of a regular octahedron when the length of one side (A) is known. Store program in area P5.

$$S = 2\sqrt{3}A^2 \quad V = \sqrt{2}/3A^3$$

MODE [2] (WRT)

```

WRT / COMP

4164 Bytes Free
IP0 empty
IP1 empty
IP2 empty
IP3 empty
    
```

▼▼▼▼▼

```

4164 Bytes Free
IP2 empty
IP3 empty
IP4 empty
IP5 empty
    
```

MODE

```

Cal mode
+:COMP
-:BASE-N
x:SD
÷:REG
ø:MATRIX
    
```

[+](COMP)

The Calculation Mode you specify becomes part of the program. Note the following precautions about Calculation Modes.

BASE-N Mode

- You cannot use scientific functions.
- You cannot specify a unit of angular measurement.
- You can use any program commands (see page 175).
- Include a "▲" symbol at the end of the program. This returns the unit to its previous Calculation Mode after the program is complete. If you forget this symbol, you may have problems following execution of BASE-N Programs.

MATRIX Mode

- You cannot use the Matrix Mode for programming. The unit will not let you enter the WRT Mode or the PCL Mode from the Matrix Mode.

[EXE] (Starts programming)

```

_
    
```

[SHIFT] [PRGM] [F4] (?) [→] [ALPHA] [A] [F6] (:)

[2] [X] [✓] [3] [X] [ALPHA] [A] [SHIFT] [x²]

[F5] (▲)

```

?→A : 2×√3×A² ▲
_
    
```

[✓] [2] [÷] [3] [X] [ALPHA] [A] [x³] [3]

```

?→A : 2×√3×A² ▲
√2÷3×A x³ 3_
    
```

MODE [1]

■ To execute a program stored in memory

Example To execute the program stored by the operation described above, for A = 10, 7 and 15

Length of one side	Surface area	Volume
10cm	(346.4101615)cm ²	(471.4045208)cm ³
7	(169.7409791)	(161.6917506)
15	(779.4228634)	(1590.990258)

MODE [1] (RUN)

```

RUN / COMP
G-type : REC/CON
angle : Rad
display : Nrm1
    
```

[SHIFT] [PRGM] [F3] (Prg) [5] [EXE]

```

?→A : 2×√3×A² ▲
√2÷3×A x³ 3
Prog 5
?
    
```

1 0 **EXE** (Value of A)

```

?→A:2×√3×A²▲
√2÷3×Ax³
Prog 5
?
10
346.4101615
- Disp -

```

(S when A=10)
“-Disp-” symbol
pauses calculation for
display of result

EXE

```

?→A:2×√3×A²▲
√2÷3×Ax³
Prog 5
?
10
346.4101615
471.4045208

```

(V when A=10)

◀(or**▶**)(REPLAY)**EXE**
(This operation repeats the
recall of the program area.)

```

Prog 5
?

```

7 **EXE** (Value of A)

```

Prog 5
?
7
169.7409791
- Disp -

```

(S when A=7)

EXE

```

Prog 5
?
7
169.7409791
161.6917506

```

(V when A=7)

◀(or**▶**)(REPLAY)**EXE**

```

Prog 5
?

```

1 5 **EXE** (Value of A)

```

Prog 5
?
15
779.4228634
- Disp -

```

(S when A=15)

EXE

```

Prog 5
?
15
779.4228634
1590.990258

```

(V when A=15)

*The unit automatically performs the programmed calculation when you press **EXE**. If calculation is suspended to display a result, press **EXE** again to resume the calculation.

■ To edit a program

Example To change the program A+B, stored in program area P3 to C+D

MODE 2 (WRT)

```
IP0 empty
IP1 empty
IP2 empty
IP3 A+B
```

▼▼▼

```
IP0 empty
IP1 empty
IP2 empty
IP3 A+B
```

EXE *

```
A+B
```

ALPHA C

```
C+B
```

▶ ALPHA D

```
C+D_
```

*The EXE key operation to enter the program area causes the cursor to be located at the beginning of the program. If you use SHIFT EXE instead, the cursor is located at the end of the program.

■ To delete a specific program

Important

•The procedures described below cannot be undone. Make sure that you do not need data any more before you delete it.

Example To delete a program stored in program area P3

MODE 3 (PCL)

PCL / COMP

```
3852 Bytes Free
IP0 'GRAPHIC'
IP1 empty
IP2 ?→A: ?→B: √(A×B)
IP3 INTEGRATION
```

▼▼▼

PCL / COMP

```
3852 Bytes Free
IP0 'GRAPHIC'
IP1 empty
IP2 ?→A: ?→B: √(A×B)
IP3 INTEGRATION
```

AC

PCL / COMP

```
3974 Bytes Free
IP0 'GRAPHIC'
IP1 empty
IP2 ?→A: ?→B: √(A×B)
IP3 empty
```

■ To clear all programs

Important

- The procedures described below cannot be undone. Make sure that you do not need data any more before you delete it.

MODE **1** (RUN)

```

RUN / COMP
G-type : POL/PLT
angle  : Rad
display:Nrm1
    
```

SHIFT **CLR**

Mcl Sci ARR PRG

F4

F4 (PRG)

YES ERASE ALL PROG **NO**

F1

F1 (YES)

```

RUN / COMP
G-type : POL/PLT
angle  : Rad
display:Nrm1
    
```

MODE **2** (WRT)

```

WRT / COMP

4164 Bytes Free
IP0 empty
IP1 empty
IP2 empty
IP3 empty
    
```

6-2 About Error Messages

Sometimes a program you enter causes an error message to appear when you execute it. This means that there is an error that needs to be corrected. The following shows a typical error message display

```

Prog 0
Syn ERROR
Step IP0-8
    
```

Error type
 Step where error occurred
 Program area where error occurred

All of the possible error messages are listed in the Error Message Table on page 205. When you get an error message, look it up in the Error Message Table and take actions to correct it.

6-3 Counting the Number of Steps

The memory of the unit can hold up to 4,164 steps. A step is a unit of data, usually represented by a single keystroke. For example, each of the following would take up 1 step of memory space.

\sin : $\boxed{\sin}$, \sin^{-1} : $\boxed{\text{SHIFT}} \boxed{\sin}$

As you input programs, the number of steps available decreases. The number of memory steps available is also decreased when you convert program memory to value memory (page 36), and when you store functions, matrices, or statistical data.

■ To check the amount of memory remaining

$\boxed{\text{MODE}} \boxed{1}$ (RUN)
 $\boxed{\text{SHIFT}} \boxed{\text{Defm}} \boxed{\text{EXE}}$

Number of steps used for programming—
 Number of value memories—
 Number of steps remaining—

```

Program : 250
F-Memory : 10
Memory : 58
Stat(SD) : 0
Stat(REG): 0
Matrix : 8
-----
3664 Bytes Free
    
```

The following procedure can also be used.

$\boxed{\text{MODE}} \boxed{2}$ (WRT)

Number of steps remaining—

```

WRT / COMP
-----
3968 Bytes Free
IP0 █ 'GRAPHIC'
IP1 empty
IP2 ?→A: ?→B: √(A×B)
IP3 INTEGRATION
    
```

You can count the steps in a program by pressing the \leftarrow and \rightarrow cursor keys. Each press of these keys causes the cursor to jump to the next step.

■ To check where the cursor is currently located

$\boxed{\text{MI}} \boxed{\text{Disp}}$

Step IP0-6

(Current location of cursor step #6)

The above screen remains on the display as long as $\boxed{\text{MI}} \boxed{\text{Disp}}$ is depressed.

6-4 Program Commands

The unit provides you with special programming commands that let you perform conditional and unconditional jumps and loops.

■ To display the program function menu

$\boxed{\text{SHIFT}} \boxed{\text{PRGM}}$

```

JMP REL PrG ? ▲ :
-----
F1 F2 F3 F4 F5 F6
    
```

The following are the operations that are available from the function display at the bottom of the screen. Press the function key below the operation you want to perform.

- $\boxed{\text{F1}}$ (JMP) Displays jump command menu
- $\boxed{\text{F2}}$ (REL) Displays relational operator menu
- $\boxed{\text{F3}}$ (Prg) Inputs "Prog" for program area specification
- $\boxed{\text{F4}}$ (?) Prompt command for value input
- $\boxed{\text{F5}}$ (▲) Display result command
- $\boxed{\text{F6}}$ (:) Multistatement connector

- The input in response to a prompt command can be a value or calculation expression up to 111 steps long. No non-calculation command or multistatement can be performed while the calculator is waiting for input in response to a prompt command.
- The display result command causes program execution to stop while the calculation result up to the display result command or a text message is displayed. To resume program execution, press $\boxed{\text{EXE}}$. The final result of the program execution is displayed regardless of whether or not this command is included at the end. Note, however, that this command should be used at the end of the BASE-N Mode program in order to return the unit to its original mode following the program.
- The multistatement connector is used to connect two or more statements together for sequential execution. Unlike statements connected by the display result command, statements connected by the multistatement connector are executed from beginning to end, non-stop. Note that you can also use the Newline Function (described below) to connect statements, and make them easier to read on the display.

■ About the Newline Function

The Newline Function is a multistatement connector that, performs a newline operation instead of inserting a ":" symbol at the connection of two statements.

Note the two following displays.

```

Deg: 0 → T: ? → V: ? → S:
Lb1 1: Isz T: Vxsi
n SxT-9. 8xT² ÷ 2▲
Goto 1
    
```

```

Deg
0 → T: ? → V: ? → S
Lb1 1: Isz T: Vxsi
n SxT-9. 8xT² ÷ 2▲
Goto 1
    
```

Both displays show the same programs, except that the upper one uses multistatement commands, while the lower one uses the Newline Function. Note how much easier the lower display is to read.

● To use the Newline Function

To perform a newline operation at the end of a statement, press **SHIFT** **↵**.

■ To display the Jump Command Menu

SHIFT **PRGM**

JMP REL PrG ? ▲ :

F1

F1(JMP)

→ Gto Lbl Dsz Isz

F1 F2 F3 F4 F5

The following are the operations that are available from the function display at the bottom of the screen. Press the function key below the operation you want to perform.

- F1**(⇒) Indicates conditional jump destination
- F2**(Gto) Indicates unconditional jump destination
- F3**(Lbl) Indicates label
- F4**(Dsz) Decrements value memory
- F5**(Isz) Increments value memory

■ To display the Relational Operator Menu

SHIFT **PRGM**

JMP REL PrG ? ▲ :

F2

F2(REL)

= ≠ > < ≥ ≤

F1 F2 F3 F4 F5 F6

The following are the operations that are available from the function display at the bottom of the screen. Press the function key below the operation you want to perform.

- F1**(=) Equal
- F2**(≠) Not equal
- F3**(>) Greater than
- F4**(<) Less than
- F5**(≥) Greater than or equal to
- F6**(≤) Less than or equal to

■ To display the Punctuation Symbol Menu

ALPHA

' " ~

F1 F2 F3

The following are the operations that are available from the function display at the bottom of the screen. Press the function key below the operation you want to perform.

- F1**(') Start of non-executable remarks
- F2**('') Indicates display text
- F3**(~) Indicates range of value memories

• The single quotation mark indicates the beginning of non-executable remarks. It is useful to insert a program name at the beginning of the program for display in the program area list (only the first 13 characters are displayed). The unit considers anything from a single quotation mark up to the next multistatement connector (:), display result command (▲), or newline operation to be part of the remarks. Remarks can contain letters or numbers.

• Double quotation marks indicate text to be shown on the display. Display text can contain letters or numbers. The unit considers anything from a double quotation mark up to the next multistatement connector (:), display result command (▲), or newline operation to be part of the display text. Display text can contain letters or numbers.

• The "~" symbol is used to indicate a range of value memories. For example, to assign a value of 10 to value memories A through F, you would specify the following:

10 → A ~ F (1) (0) (→) (ALPHA) (A) (ALPHA) (F3) (~) (ALPHA) (F)

This symbol cannot be used to assign values to value memories r or θ, but it can be used with array memories (page 184). It is most useful when you want to clear a series of value memories by assigning them with a value of zero in a program.

6-5 Using Jump Commands

Generally, programs are executed from beginning to end, in the order that they are input into memory. This can cause problems when you want to repeat an operation a number of times or when you want to execute a formula in a different location. Jump commands make it possible to accomplish such operations very easily.

■ About unconditional jumps

An unconditional jump is one that is performed no matter what circumstances exist. To use an unconditional jump with the unit, you first identify the destination of the jump with a label. Then you tell the unit at some point to go to the label and continue execution of the program.

To illustrate, we will reprogram the calculation for the surface area and volume of a regular octahedron that we originally wrote on page 166. With our previous program, we had to start the program three different times to perform our calculations. With an unconditional jump however, once we start program execution, it repeats until we tell it to stop.

● To use an unconditional jump

Example 1	Previous Program	New Program
	? , →, A, :, 2, ×, √, 3, ×, A, x ² , ▲, √, 2, ÷, 3, ×, A, x ³ , 3 20 steps	Lbl, 1, :, ?, →, A, :, 2, ×, √, 3, ×, A, x ² , ▲, √, 2, ÷, 3, ×, A, x ³ , 3, ▲, Goto, 1 26 steps

Note that in the new program, we identify the start of the program with label 1 (Lbl 1). This is where we want to jump to each time. Then at the end of the program we include the jump command to "go to label 1" (Goto 1). Input the program (using the procedures described on page 166), and you should be able to perform the following calculation.

SHIFT PRGM F3 (Prg) 0 EXE	?	
1 0 EXE	346.4101615	When A = 10
EXE	471.4045208	
EXE	?	
7 EXE	169.7409791	When A = 7
EXE	161.6917506	
EXE	?	

Since we have created an endless loop within this program, you have to press MODE 1 to stop the continuous execution.

In the above example we located the destination of the branch at the beginning of the program. Actually, you can locate destinations anywhere. Note the next example.

Example 2 To program the formula $y = Ax + B$, so that for each execution the values of A and B remain constant, but the value of X varies.

Program

? , →, A, :, ?, →, B, :, Lbl, 1, :, ?, →, X, :, A, ×, X, +, B, ▲, Goto, 1 23 steps

With this program, a prompt appears once for A and B. A prompt for X appears with each execution, of the loop back to label 1 (Lbl 1).

Note

*If your program tells the calculator to go to a label that does not exist, an error message (Go ERROR) appears on the display.

■ About conditional jumps

With a conditional jump you set up certain criteria and control whether or not the jump is actually performed. Look at the following format.

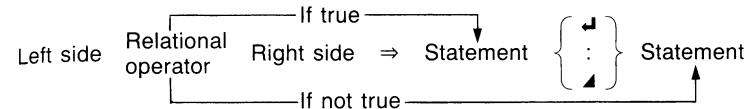

As shown above, if the condition defined by the relational operator is true, the statement following "⇒" is executed, and then the next statement is executed. If the condition is false, the statement following "⇒" is skipped.

The following are the conditions that you can define using the relational operators.

L = R	True when L and R are equal; false when L and R are not equal
L ≠ R	True when L and R are not equal; false when L and R are equal
L ≥ R	True when L is greater than or equal to R; false when L is less than R
L ≤ R	True when L is less than or equal to R; false when L is greater than R
L > R	True when L is greater than R; false when L is less than or equal to R
L < R	True when L is less than R; false when L is greater than or equal to R

● To use a conditional jump

Example 1 To write a program that calculates the square root of any input value that is greater than or equal to zero. If a value that is less than zero is input, the program ignores it and prompts further input.

Program

Lbl, 1, :, ?, →, A, :, A, ≥, 0, ⇒, √, A, ▲, Goto, 1 16 steps

This program starts out by prompting input for A. The next statement tests the input by saying: "if the value of A is greater than or equal to 0, then calculate the square root of A". This is followed by a display result command. After the result is displayed, pressing EXE continues with the Goto 1 unconditional jump to label 1 (Lbl 1) at the beginning of the program. For values that are less than 0, the square root calculation statement is skipped and execution jumps directly to the Goto 1 statement.

Example 2 To write a program that accumulates input values, but displays the total of the values any time zero is entered.

Program

```
0, →, B, :,
Lbl, 1, :, ?, →, A, :, A, =, 0, ⇒, Goto, 2, :,
A, +, B, →, B, :, Goto, 1, :,
Lbl, 2, :, B
```

31 steps

With this program, 0 is assigned to value memory B to clear it. The next statement prompts for input of a value to value memory A. The next statement is a conditional jump that says: "if the value input for A equals 0, then go to label 2". The statement following label 2 (Lbl 2) ends program execution with a display of the value memory B contents. For other values, the next statement adds value memories A and B, and then stores the result in value memory B again. After this, program execution returns to the statement following label 1 (Lbl 1), where the next input for A is prompted.

■ About count jumps

There are two count jumps: one that increments a value memory (Isz) and one that decrements a value memory (Dsz). Look at the following format.

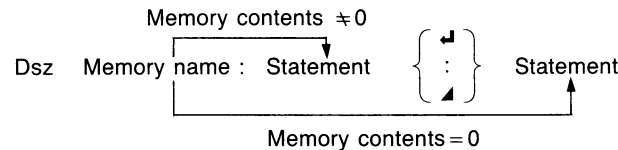
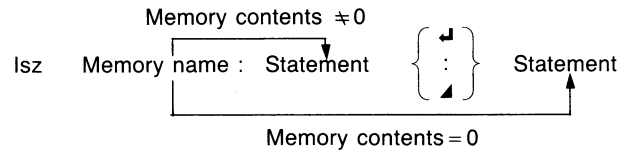

As shown above, if the increment or decrement operation does not cause the content of the value memory to become 0, the statement following the value memory name is executed. If the content of the value memory becomes 0, the next statement is skipped.

• To use a count jump

Example 1 To write a program that accepts input of 10 values, and then calculates the average of the values.

Program

```
1, 0, →, A, :, 0, →, C, :,
Lbl, 1, :, ?, →, B, :, B, +, C, →, C, :,
Dsz, A, :, Goto, 1, :, C, ÷, 1, 0
```

32 steps

This program starts out by assigning a value of 10 to A. This is because value memory A will be used as a control variable. The next statement clears C to zero. After defining the location of label 1 (Lbl 1), the program then prompts for input of a value for B. The next statement adds the value of B to value memory C, and then stores the result in C. The next three statements say: "decrement the value in A, and if it is still greater than 0, jump back to label 1; otherwise divide the contents of C by 10".

Example 2 To write a program that calculates at 1-second intervals the altitude of a ball thrown into the air at an initial velocity of Vm/sec and an angle of S°. The formula is expressed as: $h = V \cdot \sin \theta t - \frac{1}{2}gt^2$, with $g = 9.8$. The effects of air resistance should be disregarded.

Program

```
Deg, :, 0, →, T, :, ?, →, V, :, ?, →, S, :,
Lbl, 1, :, Isz, T, :, V, ×, sin, S, ×, T, -,
9, ×, 8, ×, T, x2, ÷, 2, ▲, Goto, 1
```

38 steps

With this program, the first statements specify the unit of angular measurement and clear T to 0. Then the initial velocity is prompted for V and the angle is prompted for S. Lbl 1 identifies the beginning of the repeat calculation. The value stored in T is incremented by Isz T, and in this program the Isz command is used only for incrementation, without any comparison or decision being performed. Each time T is incremented, the formula is calculated and the altitude is displayed. Note that this program is an endless loop that must be terminated by pressing **MODE** **1**.

6-6 Using Subroutines

Up to this point, all of the programs we have seen were contained in a single program area. You can also jump between program areas, so that the resulting execution is made up of pieces in different areas. In such a case, the central program from which other areas are jumped to is called a "main routine". The areas jumped to from the main routine are called "subroutines".

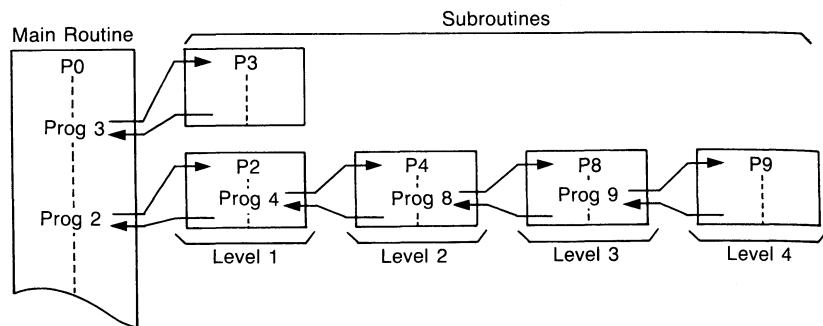

To jump to another program area, use the "Prog" command (**SHIFT** **PRGM** **F3**(Prg)), followed by the name of the program area you want to jump to.

Example **Prog 0** — Jumps to program area 0
Prog T — Jumps to program area T

After the jump to the program area you specify, execution continues from the beginning of the subroutine stored in the specified program area. When end of the subroutine is reached, execution returns to the statement following the Prog command that initiated the subroutine.

You can jump from one subroutine to another, a procedure that is called "nesting". You can nest up to a maximum of 10 levels, and an error will occur (Ne ERROR) if you try to nest an 11th time. If you try to jump to a program area that does not contain a program, an error message (Go ERROR) will appear on the display.

Important

- The Goto command does not jump between program areas. A Goto command jumps to the label (Lbl) located inside the same program area.

Subroutines save memory

Note the following two programs.

P0 Fix, 3, :, ?, →, A, :, 2, ×, √, 3, ×, A, x², ▲,
√, 2, ÷, 3, ×, A, x^y, 3 23 steps

P1 Fix, 3, :, ?, →, A, :, √, 3, ×, A, x², ▲,
√, 2, ÷, 1, 2, ×, A, x^y, 3 22 steps

If we input these two programs separately, they require a total of 45 steps. But note that the underlined portions of these two programs are identical. This means that these parts can be stored as subroutines and called by both of the programs.

If we use subroutines, we get the following results.

Subroutines

P9 Fix, 3, :, ?, →, A, :, √, 3, ×, A, x² 12 steps
P8 √, 2, ÷, 3, ×, A, x^y, 3 8 steps

Main routines

P0 Prog, 9, :, Ans, ×, 2, ▲, Prog, 8 9 steps
P1 Prog, 9, ▲, Prog, 8, :, Ans, ÷, 4 9 steps

As you can see, the number of steps required to store the two programs and the subroutines is 38, for a saving of 7 steps.

When you execute the program in program area 0, it immediately jumps to P9 and executes the contents of that program area. At the end of P9, execution returns to P0 where the result produced by the subroutine in P9 is multiplied by 2 and then displayed. After you press the **EXE** key, execution jumps to P8, where the remainder of the program is executed.

With the main routine in program area P1, execution jumps immediately from program area P9. At the end of P9 execution returns to P1 where the P9 result is displayed. When you press **EXE**, execution jumps again to P8. At the end of P8, execution returns to P1, where the result produced by P8 is divided by 4 and displayed.

6-7 Using Array Memory

In addition to the individual value memories, the unit gives you array memory capabilities. Note the following.

Value Memories	Array Memories
A	A[0] C[-2]
B	A[1] C[-1]
C	A[2] C[0]
D	A[3] C[1]
E	A[4] C[2]

Note)

*You cannot use r or θ value memory as array memory.

As you can see, array memory names consist of an alphabetic character, followed by a *subscript* enclosed in brackets. The subscript is a value, either positive or negative, or a value memory that represents a value. If the value of 5 is assigned to value memory X, for example, the array memory A[X] would be equivalent to A[5].

■ Array memories simplify programming

Since the subscript of an array memory can be a value memory name, programming becomes more economical. Note the following.

Example To write a program that assigns the values from 1 through 10 to memories A through J

Using value memories

```
1, →, A, :, 2, →, B, :, 3, →, C, :, 4, →, D, :,
5, →, E, :, 6, →, F, :, 7, →, G, :, 8, →, H, :,
9, →, I, :, 1, 0, →, J
```

40 steps

Using array memories

```
0, →, Z, :, Lbl, 1, :, Z, +, 1, →, A, [, Z, ], :,
Isz, Z, :, Z, <, 1, 0, ⇒, Goto, 1
```

26 steps

As you can see, using array memories uses 14 fewer steps. You get even more economy with the following program.

Example To write a program that displays the contents of a memory specified by input

Using value memories

```
Lbl, 1, :, ?, →, Z, :,
Z, =, 1, ⇒, A, ▲, Z, =, 2, ⇒, B, ▲,
Z, =, 3, ⇒, C, ▲, Z, =, 4, ⇒, D, ▲,
Z, =, 5, ⇒, E, ▲, Z, =, 6, ⇒, F, ▲,
Z, =, 7, ⇒, G, ▲, Z, =, 8, ⇒, H, ▲,
Z, =, 9, ⇒, I, ▲, Z, =, 1, 0, ⇒, J, ▲,
Goto, 1
```

70 steps

Using array memories

```
Lbl, 1, :, ?, →, Z, :, A, [, Z, -, 1, ], ▲,
Goto, 1
```

16 steps

With value memories, logical operations are used to test the input until the proper memory is found. With array memories, on the other hand, the specified memory is found immediately.

■ Cautions when using array memories

You should remember that array memories are actually based on value memories. Note the following relationship.

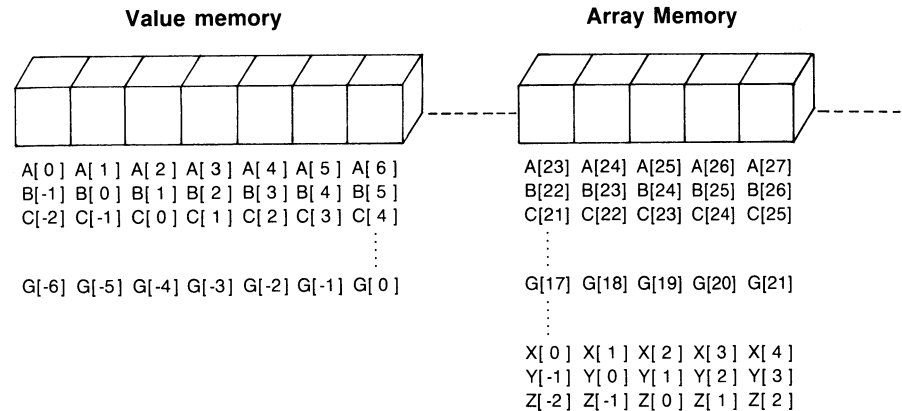

This means that you must be careful when using array memories that you do not overlap. Note the following.

Example To write a program that stores values from 1 through 5 in memories A[1] through A[5]

Writing the above program as follows results in an overlap of memory.

```
5, →, C, :, Lbl, 1, :, C, →, A, [, C, ], :,
Dsz, C, :, Goto, 1, :,
A, [, 1, ], ▲, A, [, 2, ], ▲, A, [, 3, ], ▲,
A, [, 4, ], ▲, A, [, 5, ]
```

44 steps

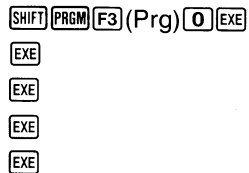

1.
0.
3.
4.
5.

We would expect the second execution to produce a 2, but it actually produces a 0 instead. This is because array memory A[2] is actually identical to value memory C, which is counted down to 0 by the end of the program. Remember the following relationship.

Value memory: A B C D E F
Array memory: A[1] A[2] A[3] A[4] A[5]

Since we are using array memories A[1] through A[5] to store values in the above program, we can avoid overlap by using value memory C or greater for storing the counter value.

Sample Programs that Use Array Memory

The following programs store *x* and *y* data in array memories. Whenever an *x* value is input, the corresponding *y* value is displayed. You can input a total of 15 sets of data.

Example 1 With this version of the program, value memory A is used as a data control memory, while memory B is used for temporary storage of *x* data. The *x* data is stored in memories C[1] (value memory D) through C[15] (value memory R), while the *y* data is stored in memories C[16] (value memory S) through C[30] (value memory Z[7]).

```
1, →, A, :, Defm, 7, :,
Lbl, 1, :, ?, →, C, [, A, ], :,
?, →, C, [, A, +, 1, 5, ], :,
Isz, A, :, A, =, 1, 6, ⇒, Goto, 2, :, Goto, 1, :,
Lbl, 2, :, 1, 5, →, A, :, ?, →, B, :,
B, =, 0, ⇒, Goto, 5, :,
Lbl, 3, :, B, =, C, [, A, ], ⇒, Goto, 4, :,
Dsz, A, :, Goto, 3, :, Goto, 2, :,
Lbl, 4, :, C, [, A, +, 1, 5, ], ▲, Goto, 2, :,
Lbl, 5
```

98 steps

The above program uses value memories as follows:

x data

C[1]	C[2]	C[3]	C[4]	C[5]	C[6]	C[7]	C[8]	C[9]	C[10]
D	E	F	G	H	I	J	K	L	M
C[11]	C[12]	C[13]	C[14]	C[15]					
N	O	P	Q	R					

y data

C[16]	C[17]	C[18]	C[19]	C[20]	C[21]	C[22]	C[23]	C[24]	C[25]
S	T	U	V	W	X	Y	Z	Z(1)	Z(2)
C[26]	C[27]	C[28]	C[29]	C[30]					
Z(3)	Z(4)	Z(5)	Z(6)	Z(7)					

Example 2 This version is identical to Example 1, except that a different letter is used for the *x* and *y* data names.

```
1, →, A, :, Defm, 7, :,
Lbl, 1, :, ?, →, C, [, A, ], :,
?, →, R, [, A, ], :,
Isz, A, :, A, =, 1, 6, ⇒, Goto, 2, :, Goto, 1, :,
Lbl, 2, :, 1, 5, →, A, :, ?, →, B, :,
B, =, 0, ⇒, Goto, 5, :,
Lbl, 3, :, B, =, C, [, A, ], ⇒, Goto, 4, :,
Dsz, A, :, Goto, 3, :, Goto, 2, :,
Lbl, 4, :, R, [, A, ], ▲, Goto, 2, :,
Lbl, 5
```

92 steps

This above program uses value memories as follows:

x data

C[1]	C[2]	C[3]	C[4]	C[5]	C[6]	C[7]	C[8]	C[9]	C[10]
D	E	F	G	H	I	J	K	L	M
C[11]	C[12]	C[13]	C[14]	C[15]					
N	O	P	Q	R					

y data

R[1]	R[2]	R[3]	R[4]	R[5]	R[6]	R[7]	R[8]	R[9]	R[10]
S	T	U	V	W	X	Y	Z	Z(1)	Z(2)
R[11]	R[12]	R[13]	R[14]	R[15]					
Z(3)	Z(4)	Z(5)	Z(6)	Z(7)					

Note that in the above two programs the Defm command was necessary to increase the number of value memories.

6-8 Displaying Text Messages

Text, numbers, and symbols can be displayed by programs as messages that prompt input, etc. Note the following example.

Statement	Display
Without text ? → X	?
With text "X=" ? → X	X=?

As you can see, the text prompt makes it much easier to understand what input is required by the program.

Messages can also be used to explain the meaning of a displayed result.

Example

```
Lbl, 0, :, ", N, =, ", ?, →, B, ~, C, :,
0, →, A, :,
Lbl, 1, :, C, ÷, 2, →, C, :, Frac, C, ÷, 0, ⇒, Goto, 3,
:, Isz, A, :, C, =, 1, ⇒, Goto, 2, :, Goto, 1, :,
Lbl, 2, :, ", X, =, ", ▲, A, ▲, Goto, 0, :,
Lbl, 3, :, ", N, O, ", ▲, Goto, 0
```

70 steps

This program prompts for input of a value. If the input value is equivalent to 2^x , it displays the value of x . If the input value is not equivalent to 2^x , it displays the message "NO".

Important

Be sure to follow the message with a display result command if there is another statement following the message.

Assuming that the program is stored in P2:

```
SHIFT PRGM F3 (Prg) 2 EXE
4 0 9 6 EXE
EXE
EXE
3 1 2 4 EXE
EXE
5 1 2 EXE
EXE
```

N=?
X=
12.
N=?
NO
N=?
X=
9.

Text that is longer than 16 characters is displayed in two lines. When text is comes at the bottom of the display, the entire screen scrolls upwards.

SHIFT PRGM F3 (Prg) 0

```
123+45
852-87
968+125-65
Prog 0_
UMP REL Prg ? ▲ :
```

EXE

```
852-87
968+125-65
Prog 0
ABCDEFGHIJKLMNPO
```

↓ After a while

```
852-87
968+125-65
Prog 0
ABCDEFGHIJKLMNPO
QRSTUVWXYZ
```

6-9 Using the Graph Function in Programs

By using the graph function in programs, you can graphically represent long, complex equations and overdraw graphs a number of times. All graph commands (except the Trace Function) can be used in programs. You can also specify range parameters in programs.

Example To graphically represent the number of solutions (real roots) that satisfy both of the following equations

$$y = x^4 - x^3 - 24x^2 + 4x + 80$$

$$y = 10x - 30$$

Use the following range parameters.

Xmin : -10
max: 10
scl : 2
Ymin : -120
max: 150
scl : 50

First, program the range parameters. Note that parameters are separated by commas. Press **EXE** at the end.

• There are a total of nine range parameters (Xmin, Xmax, Xscl, Ymin, Ymax, Yscl, T/θmin, T/θmax, ptch).

Range, (-), 1, 0, , 1, 0, , 2, , (-), 1, 2, 0, , 1, 5, 0, , 5, 0

Next, program the equation for the first graph. Press **EXE** at the end.

Graph, X, x^y, 4, -, X, x^y, 3, -, 2, 4, X, x², +, 4, X, +, 8, 0

Finally, program the equation for the second graph.

Graph, 1, 0, X, -, 3, 0

Total: 49 steps

The above program should produce this graph when you execute it.

EXE

Range -10, 10, 2, -
120, 150, 50
Graph Y=Xx ^y 4-Xx ^y
3-24X ² +4X+80
Graph Y=10X-30

MODE **1** **SHIFT** **PRGM** **F3** (Prg) **0** **EXE**

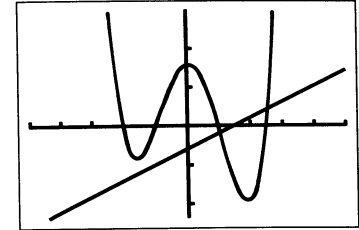

You could use a display result command (**▲**) in place of the **EXE** operation at the end of the first equation. This will cause execution to stop after the first graph is drawn. To resume execution, press **EXE**.



Appendix

The appendix contains information on battery replacement, error messages, specifications, and other details.

- Appendix A Power Supply
- Appendix B To Reset the Calculator
- Appendix C Function Reference
- Appendix D Error Message Table
- Appendix E Input Ranges
- Appendix F Specifications

Appendix A Power Supply

The unit is powered by three CR2032 lithium batteries. In addition, it uses a single CR2032 lithium battery as a back up power supply for the memory.

■ When to Replace Batteries

Replace batteries when the display of the calculator becomes dim and difficult to read, even if you adjust the contrast (page 23) to make it darker.

If the following message appears on the display, immediately stop using the calculator and replace batteries. If you try to continue using the calculator, it will automatically switch power off, in order to protect memory contents.

You will not be able to switch power back on until you replace batteries.

Low battery
Step 41

Be sure to replace batteries **at least once every 5 years**, no matter how much you use the calculator during that time.

Warning!

If you remove both the main power supply and the memory back up batteries at the same time, all memory contents will be erased. Be sure to read the following section before doing anything.

■ Replacing Batteries

- Be sure that you have back up copies of all your memory contents before replacing batteries.
- Never remove the main power supply and the memory back up batteries at the same time. Doing so will erase the contents of the memory.
- Be sure that the calculator is switched off whenever you replace batteries. If the calculator is on, data stored in memory will be erased.
- Never switch the calculator on while batteries are not loaded or while a battery holder is not in place. Doing so will erase the contents of the memory.

Precautions:

Incorrectly using batteries can cause them to burst or leak, possibly damaging the interior of the unit. Note the following precautions:

- Be sure that the positive \oplus and negative \ominus poles of each battery are facing in the proper direction.
- Never mix batteries of different types.
- Never mix old batteries and new ones.
- Never leave dead batteries in the battery compartment.
- Remove the batteries if you do not plan to use the unit for long periods.
- Never try to recharge the batteries supplied with the unit.
- Do not expose batteries to direct heat, let them become shorted, or try to take them apart.



Keep batteries out of the reach of small children. If swallowed, consult with a physician immediately.

● **To replace the main power supply batteries**

- ① Switch the power of the calculator off.
- ② Carefully remove the 2 screws that hold the back cover of the calculator in place and then remove the back cover.
- ③ Slide the switch on the battery holder to the left (OPEN side) and remove screw (A).

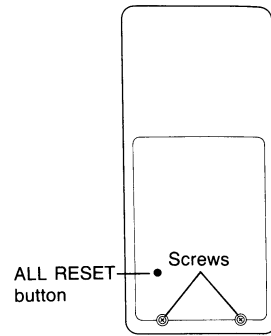
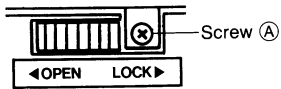

- ④ Remove the three old batteries.
- ⑤ Wipe off the surfaces of three new batteries with a soft, dry cloth. Load the three new batteries into the calculator so that their positive (+) sides are facing up. Be sure to replace all three batteries with three new ones.

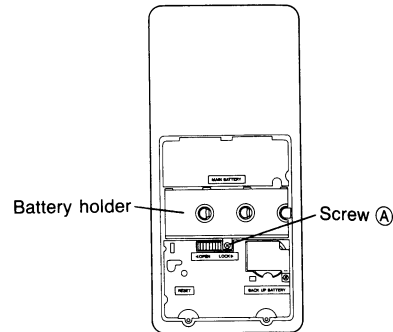

- ⑥ Replace the battery holder and fasten it in place with screw (A). Slide the switch back to the right (LOCK side).

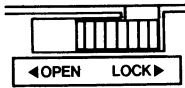

- ⑦ Replace the back cover of the calculator and fasten it in place with the screws.
- ⑧ Switch the power of the calculator on and check for proper operation.

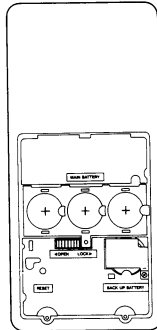

Important

- *Do not remove the main power supply and the memory back up batteries from the unit at the same time.
- *Do not leave the unit for long periods with the main power supply batteries removed. This puts too much of a drain on the memory back up battery.

● **To replace the memory back up battery**

- ① Switch the power of the calculator off.
- ② Carefully remove the 2 screws that hold the back cover of the calculator in place and then remove the back cover.
- ③ Remove screw (B) from the battery holder.
- ④ Remove the old battery.
- ⑤ Wipe off the surfaces of a new battery with a soft, dry cloth. Load it into the calculator so that its positive (+) side is facing up.
- ⑥ Replace the battery holder and fasten it in place with screw (B).
- ⑦ Replace the back cover of the calculator and fasten it in place with the screws.
- ⑧ Switch the power of the calculator on and check for proper operation.

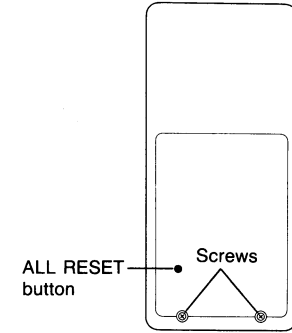

- ⑥ Replace the battery holder and fasten it in place with screw (B).
- ⑦ Replace the back cover of the calculator and fasten it in place with the screws.

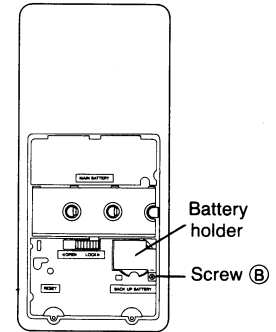

- ⑧ Switch the power of the calculator on and check for proper operation.

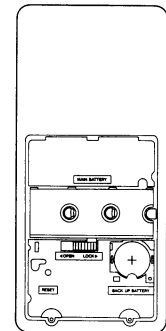

Important

- *Do not remove the main power supply and the memory back up batteries from the unit at the same time.
- *Replace the memory back up battery at least once every 5 years, regardless of how much you use the calculator during that time.

■ **About the Auto Power Off Function**

The calculator switches power off automatically if you do not perform any key operation for about 6 minutes. To restore power, press **AC** ON.

Appendix B To Reset the Calculator

Warning!

The procedure described here clears all memory contents. Never perform this operation unless you want to totally clear the memory of the calculator.

Strong electrostatic charge can corrupt the operating system of the calculator, which interferes with correct operation. When this happens (or if you want to totally clear the memory for any other reason), you have to reset the calculator.

• To reset the calculator

- ① Press the RESET button on the back of the calculator with a thin, pointed object.
- ② A message appears on the display to confirm whether or not you really want a reset.

YES RESET ALL NO

Press **F1**(YES) to reset or **F6**(NO) to abort the operation without resetting or clearing anything.

Resetting the calculator initializes the modes to the following settings.

Item	Initial Setting
Mode Menu	COMP
Unit of Angular Measurement	Deg
Norm	Norm1
BASE-N	DEC
Value Memory	Clear
Function Memory	Clear
Calculation Memory	Clear
Program Memory	Clear
Matrix A/B	2×2

Appendix C Function Reference

■ Manual Calculations

Mode specification	COMP Mode (MODE +)	Four arithmetic and function calculations.
	BASE-N Mode (MODE □)	Binary, octal, decimal, hexadecimal conversions and calculations, logical operations.
	SD Mode (MODE ×)	Standard deviation calculations (1-variable statistical).
	REG Mode (MODE +)	Regression calculations (paired variable statistical).
	MATRIX Mode (MODE 0)	Matrix calculations
Statistical graph	SD Mode (MODE ×) (MODE SHIFT 3)	For production of single variable statistical graphs. (Bar graphs, line graphs, normal distribution curves)
	REG Mode (MODE +) (MODE SHIFT 3)	For production of paired variable statistical graphs. (Regression lines)
Functions	Type A functions	Function command input immediately after numeric value. [x^2 , x^{-1} , $x!$, $^\circ$ ' ', ENG symbols]
	Type B functions	Function command input immediately before numeric value. (sin, cos, tan, \sin^{-1} , \cos^{-1} , \tan^{-1} , sinh, cosh, tanh, \sinh^{-1} , \cosh^{-1} , \tanh^{-1} , log, ln, e^x , 10^x , $\sqrt{\quad}$, $\sqrt[3]{\quad}$, etc.)
	Paired variable functions	Function command input between two numeric values. Numeric value enclosed in parentheses input immediately after function command. ($A \times^y B$ (A to the Bth power), $B \sqrt[x]{A}$ (A to the 1/Bth power), Pol (A, B), Rec (A, B)) *A and B are numeric values.
	Immediately executed functions	Displayed value changed with each press of a key. [ENG, \leftarrow ENG, \leftarrow ' '']

Binary, octal, decimal, hexadecimal calculations MODE	Setting number system	Decimal F1 (Dec) EXE Hexadecimal F2 (Hex) EXE Binary F3 (Bin) EXE Octal F4 (Oct) EXE
	Number system specification	Number system for the numeric value entered immediately after can be specified regardless of the currently set number system. To specify: Decimal F5 (d~o) F1 (d) Hexadecimal F5 (d~o) F2 (h) Binary F5 (d~o) F3 (b) Octal F5 (d~o) F4 (o)
	Logical operations	Input numeric values are converted to binary and each bit is tested. Result is converted back to number system used for input, and then displayed. Not Reverse of each bit and Logical product of each bit or Logical sum of each bit xor Exclusive logical sum of each bit xnor Exclusive negative logical sum of each bit
Standard deviation calculations MODE	Data clear	SHIFT CLR F2 (Scl) EXE
	Data input	Data [;frequency] F1 (DT) *Frequency can be omitted.
	Data deletion	Data [;frequency] F2 (CL) *Frequency can be omitted.
	Result display	Number of data (n) F5 (Σ) F3 (n) EXE Sum (Σx) F5 (Σ) F2 (Σx) EXE Sum of squares (Σx^2) F5 (Σ) F1 (Σx^2) EXE Mean (\bar{x}) F4 (DEV) F1 (\bar{x}) EXE Population standard deviation ($x\sigma_n$) F4 (DEV) F2 ($x\sigma_n$) EXE Sample standard deviation ($x\sigma_{n-1}$) F4 (DEV) F3 ($x\sigma_{n-1}$) EXE

Regression calculations MODE	Data clear	SHIFT CLR F2 (Scl) EXE
	Data input	x data, y data [;frequency] F1 (DT) *Frequency can be omitted.
	Data deletion	x data, y data [;frequency] F2 (CL) *Frequency can be omitted.
	Result display	Number of data (n) F6 (Σ) F3 (n) EXE Sum of x (Σx) F6 (Σ) F2 (Σx) EXE Sum of y (Σy) F6 (Σ) F5 (Σy) EXE Sum of squares of x (Σx^2) F6 (Σ) F1 (Σx^2) EXE Sum of squares of y (Σy^2) F6 (Σ) F4 (Σy^2) EXE Sum of products of x and y (Σxy) F6 (Σ) F6 (Σxy) EXE Mean of x (\bar{x}) F4 (DEV) F1 (\bar{x}) EXE Mean of y (\bar{y}) F4 (DEV) F4 (\bar{y}) EXE Population standard deviation of x ($x\sigma_n$) F4 (DEV) F2 ($x\sigma_n$) EXE Population standard deviation of y ($y\sigma_n$) F4 (DEV) F5 ($y\sigma_n$) EXE Sample standard deviation of x ($x\sigma_{n-1}$) F4 (DEV) F3 ($x\sigma_{n-1}$) EXE Sample standard deviation of y ($y\sigma_{n-1}$) F4 (DEV) F6 ($y\sigma_{n-1}$) EXE Constant term of regression formula (A) F6 (REG) F1 (A) EXE Regression coefficient (B) F6 (REG) F2 (B) EXE Correlation coefficient (r) F6 (REG) F3 (r) EXE Estimated value of x (\hat{x}) F6 (REG) y data F4 (\hat{x}) EXE Estimated value of y (\hat{y}) F6 (REG) x data F5 (\hat{y}) EXE

Special functions	Ans	The latest result obtained in manual or program calculations is stored in memory. It is recalled by pressing ANS . <i>*Mantissa of numeric value is 13 digits.</i>
	Replay	<ul style="list-style-type: none"> •After calculation results are obtained, the formula can be recalled by pressing either ◀ or ▶. •If an error is generated, pressing either ◀ or ▶ will cancel the error and the point where the error was generated will be indicated by a blinking cursor.
	Multistatement	Colons are used to join a series of statements or calculation formulas. If joined using "▲", the calculation result to that point is displayed.
	Memory	The number of memories can be expanded from the standard 28. Memories can be expanded in units of one up to 520 (for a total of 548). Eight steps are required for one memory. SHIFT DEL number of memories EXE .
	Graph function	<p>Range</p> <p>Graph range settings</p> <p>Xmin Minimum value of x</p> <p>Xmax Maximum value of x</p> <p>Xscl Scale of X-axis (space between points)</p> <p>Ymin Minimum value of y</p> <p>Ymax Maximum value of y</p> <p>Yscl Scale of Y-axis (space between points)</p> <p>T, θ min ... Minimum value of T/θ</p> <p>T, θ max ... Maximum value of T/θ</p> <p>T, θ ptch ... Pitch of T/θ</p> <p>Trace</p> <p>Moves pointer on graph. Current coordinate location is displayed.</p> <p>Plot</p> <p>Marks pointer (blinking dot) at any coordinate on the graph display.</p> <p>Line</p> <p>Connects with a straight line two points created with plot function.</p> <p>Box</p> <p>Defines area for zoom in.</p> <p>Factor</p> <p>Defines factor for zoom in/zoom out.</p> <p>Original</p> <p>Returns graph to original dimensions after zoom operation.</p> <p>Scroll</p> <p>Scrolls screen to view parts of graphs that are off the display.</p>

■ Program Calculations

Program input	Input mode	WRT Mode (MODE 2)
	Calculation mode	Mode that conforms with program specified by: MODE + , MODE - , MODE X , MODE ÷ .
	Program area specification	Cursor is moved to the desired program area name (P0 through P9, PA through PZ, Pr, P θ) using ▲ and ▼ , and EXE is pressed.
Program execution	Execution mode	RUN Mode (MODE 1)
	Program area specification	Execution starts with SHIFT PRGM F3 (Prg) program area name EXE . Program area name: P0 through P9, PA through PZ, Pr, P θ
Program editing	Input mode	WRT Mode (MODE 2)
	Program area specification	Cursor is moved to the desired program area name (P0 through P9, PA through PZ, Pr, P θ) using ▲ or ▼ , and EXE is pressed.
	Editing	Cursor is moved to position to be edited using ◀ , ▶ , ▲ or ▼ . <ul style="list-style-type: none"> •Press correct key for corrections. •Press DEL for deletions. •Press SHIFT INS to specify insert mode for insertion.
Program delete	Clear mode	PCL Mode (MODE 3)
	Deletes specific program	Cursor is moved to the desired program area name (P0 through P9, PA through PZ, Pr, P θ) using ▲ and ▼ , and AC is pressed.
	Clears all programs	In RUN Mode (MODE 1), press SHIFT CLR F4 (PRG) F1 (YES)

Program commands	Unconditional jump	Program execution jumps to the Lbl n which corresponds to Goto n . * $n = 0$ through 9
	Conditional jumps	<p>If conditional expression is true, the statement after “\Rightarrow” is executed. If not true, execution jumps to the statement following next “\downarrow”, “$:$” or “\blacktriangle”.</p> <p>(F): Formula (R): Relational operator (S): Statement</p> <p>*The relational operator is: =, \neq, >, <, \geq, \leq.</p>
	Count jumps	<p>The value in a memory is increased or decreased. If the value does not equal 0, the next statement is executed. If it is 0, a jump is performed to the statement following the next “\downarrow”, “$:$” or “\blacktriangle”.</p> <p>Increase Isz Memory name : (S) : (S) When (V) \neq 0 When (V) = 0</p> <p>Decrease Dsz Memory name : (S) : (S) When (V) \neq 0 When (V) = 0</p> <p>(S): Statement (V): Value in memory</p>
	Subroutines	Program execution jumps from main routine to subroutine indicated by Prog n ($n=0$ through 9, A through Z, r, θ). After execution of the subroutine, execution returns to the point following Prog n in the original program area.

Appendix D Error Message Table

Message	Meaning	Countermeasure
Syn ERROR	<ul style="list-style-type: none"> ① Calculation formula contains an error. ② Formula in a program contains an error. 	<ul style="list-style-type: none"> ① Use ◀ or ▶ to display the point where the error was generated and correct it. ② Use ◀ or ▶ to display the point where the error was generated and then correct the program in the WRT Mode.
Ma ERROR	<ul style="list-style-type: none"> ① Calculation result exceeds calculation range. ② Calculation is performed outside the input range of a function. ③ Illogical operation (division by zero, etc.) 	<ul style="list-style-type: none"> ①②③ Check the input numeric value and correct it. When using memories, check that the numeric values stored in memories are correct.
Go ERROR	<ul style="list-style-type: none"> ① No corresponding Lbl n for Goto n. ② No program stored in program area P n which corresponds to Prog n. 	<ul style="list-style-type: none"> ① Correctly input a Lbl n to correspond to the Goto n, or delete the Goto n if not required. ② Store a program in program area P n to correspond to Prog n, or delete the Prog n if not required.
Ne ERROR	<ul style="list-style-type: none"> • Nesting of subroutines by Prog n exceeds 10 levels. 	<ul style="list-style-type: none"> • Ensure that Prog n is not used to return from subroutines to main routine. If used, delete any unnecessary Prog n. • Trace the subroutine jump destinations and ensure that no jumps are made back to the original program area. Ensure that returns are made correctly.
Stk ERROR	<ul style="list-style-type: none"> • Execution of calculations that exceed the capacity of the stack for numeric values or stack for calculations. 	<ul style="list-style-type: none"> • Simplify the formulas to keep stacks within 10 levels for the numeric values and 26 levels for the calculations. • Divide the formula into two or more parts.

Mem ERROR	<ul style="list-style-type: none"> ① Attempt to use a value memory that does not exist. ② Not enough memory to perform specified matrix operation. ③ Not enough memory to reserve work area for matrix operation. ④ Not enough memory to store statistical data. ⑤ Not enough memory to store function memory data. 	<ul style="list-style-type: none"> ① Create more value memories using Defm command, or use proper memory name. ② ③ ④ ⑤ Use SHIFT Defm EXE to check memory status. Delete no longer necessary data to make room in memory.
Arg ERROR	Incorrect argument specification for a command that requires an argument.	Correct the argument. <ul style="list-style-type: none"> •Sci n, Fix n: n = natural number from 0 through 9. •Goto n, Lbl n: n = natural number from 0 through 9. •Prog n: n = 0 through 9, A through Z, r, θ •Defm n: n = natural number between 0 and the number of remaining steps.
Dim ERROR	<ul style="list-style-type: none"> •Illegal dimension used during matrix calculations. •Attempt to exchange with matrix that does not exist. 	•Check matrices.

Appendix E Input Ranges

Function name	Input range
$\sin x, \cos x, \tan x$	$ x < 9 \times 10^9$ degree $ x < 5 \times 10^7 \pi$ rad $ x < 10^{10}$ gra
$\sin^{-1}x, \cos^{-1}x$	$ x \leq 1$
$\tan^{-1}x$	$ x < 10^{100}$
e^x	$-10^{100} < x \leq 230.2585092$
$\sinh x, \cosh x$	$ x \leq 230.2585092$
$\tanh x$	$ x < 10^{100}$
$\sinh^{-1}x$	$ x < 5 \times 10^{99}$
$\cosh^{-1}x$	$1 \leq x < 5 \times 10^{99}$
$\tanh^{-1}x$	$ x < 1$
$\log x, \ln x$	$0 < x < 10^{100}$
10^x	$-10^{100} < x < 100$
\sqrt{x}	$0 \leq x < 10^{100}$
x^2	$ x < 10^{50}$
$x^{-1} (1/x)$	$ x < 10^{100}, x \neq 0$
$\sqrt[3]{x}$	$ x < 10^{100}$
$x!$	$0 \leq x \leq 69$ (x is an integer.)
x^y	When $x < 0$, y is a natural number. $x = 0 \rightarrow y > 0$
$\sqrt[y]{y} (y^{1/x})$	$x \geq 0, y \neq 0$
Pol (x, y)	$ x < 10^{100}, y < 10^{100}$ However, $\sqrt{x^2 + y^2} < 10^{100}$
Rec (r, θ)	$ r < 10^{100}, \theta \leq 9 \times 10^9$ degree $ \theta \leq 5 \times 10^7 \pi$ rad $ \theta < 10^{10}$ gra
Binary number	(Positive) 1111111111111111 $\geq x \geq 0$ (Negative) 1111111111111111 $\geq x \geq 1000000000000000$
Octal number	(Positive) 1777777777 $\geq x \geq 0$ (Negative) 3777777777 $\geq x \geq 20000000000$
Hexadecimal number	(Positive) 7 FFFFFFFF $\geq x \geq 0$ (Negative) FFFFFFFF $\geq x \geq 800000000$
Decimal \rightarrow sexagesimal	$ x \leq 9999999.999$. If degrees, minutes and seconds exceed a total of 11 digits, the higher (degrees, minutes) values will be given priority, and displayed in 11 digits.
Statistical calculation	$ x < 10^{50}, y < 10^{50}, n < 10^{100}$

*As a rule, the accuracy of a result is ± 1 at the 10th digit.

*Errors may be cumulative with such internal continuous calculations with the functions, $x^y, \sqrt[y]{y}, x!, \sqrt[3]{x}$, and accuracy is sometimes affected.

*In $\tan x, |x| \neq 90^\circ \times (2n+1), |x| \neq \pi/2 \text{ rad} \times (2n+1), |x| \neq 100 \text{ gra} (2n+1)$, (n is an integer.)

*With $\sinh x$ and $\tanh x$, when $x=0$, errors are cumulative and accuracy is affected.

Appendix F Specifications

Model: fx-7700G

Graph functions

Built-in function graphs (Rectangular and Polar coordinates):

(40 types) sin, cos, tan, \sin^{-1} , \cos^{-1} , \tan^{-1} , sinh, cosh, tanh, \sinh^{-1} , \cosh^{-1} , \tanh^{-1} , log, ln, 10^x , e^x , x^2 , $\sqrt{\quad}$, $\sqrt[3]{\quad}$, x^{-1}

Types of graphs: User generated function graphs

Rectangular coordinates

Polar coordinates

Parametrics

Inequalities ($Y >$, $Y <$, $Y \geq$, $Y \leq$)

Integrations

Single-variable statistics: bar graphs, line graphs, normal distribution curves, Probability distributions (P, Q, R)

Paired-variable statistics: regression lines

Graph functions: Range specification, Overdraw, Trace, Zoom ($\times f$, $\times 1/f$, box zoom, factor, original (resume)), Plot, Line, Scroll

Calculations

Basic calculation functions:

Negative numbers, exponents, parenthetical addition/subtraction/multiplication/division (with priority sequence judgement function — true algebraic logic).

Built-in scientific functions:

Trigonometric/inverse trigonometric functions (units of angular measurement: degrees, radians, grads), hyperbolic/inverse hyperbolic functions, logarithmic/exponential functions, reciprocal, factorials, square roots, cube roots, powers, roots, squares, decimal-sexagesimal conversions, binary/octal/hexadecimal calculations, permutations/combinations, π , random numbers, absolute values, internal rounding, fraction functions, engineering, engineering symbol calculations (11 types)

Matrix operations:

Addition/subtraction/multiplication, scalar product, transposed matrix, determinant, inverse matrix, matrix A/matrix B exchange, matrix C transfer, matrix editing.

Integrations: Using Simpson's rule.

Statistics:

Single-variable statistics — number of data, sum, sum of squares, mean, standard deviation (two types), data storage calculation, edit function, probability distribution (P, Q, R, t)
Paired-variable statistics — number of data, sum of x , sum of y , sum of squares of x , sum of squares of y , mean of x , mean of y , standard deviation of x (two types), standard deviation of y (two types), constant term, regression coefficient, correlation coefficient, estimated value of x , estimated value of y , data storage calculation, edit function

Formula memory:

Capabilities: Formula storage, formula recall, formula execution, list display

Maximum number of steps per formula: 127 steps

Number of formulas storable: 6 maximum.

Special functions:

Insert, delete, replay functions, substitution (=), multistatement (: and \blacktriangleleft).

Memories: 28 standard (maximum 548), Ans memory

Calculation range:

$1 \times 10^{99} \sim 9.999999999 \times 10^{99}$ and 0. Internal operation uses 13-digit mantissa.

Rounding:

Performed according to the specified number of significant digits or the number of specified decimal places.

Exponential display: Norm 1 — $10^{-2} > |x|$, $|x| \geq 10^{10}$

Norm 2 — $10^{-9} > |x|$, $|x| \geq 10^{10}$

Program function

Number of steps: 4,164 maximum (4 steps with 548 memories)

Jump functions: Unconditional jump (Goto), 10 maximum

Conditional jump (=, \neq , $>$, $<$, \geq , \leq)

Count jumps (Isz, Dsz)

Subroutines: 10 levels

Number of stored programs: 38 maximum (P0~P9, PA~PZ, Pr, P θ)

Check functions: Program checking, debugging, deletion, addition, insertion, etc.

General

- Display system:** Liquid crystal display, 10-digit mantissa plus 2-digit exponent.
16 characters by 8 lines (96 by 64 dots).
- Power supply:** Main — 3 lithium batteries (CR2032)
Memory protection — 1 lithium battery (CR2032)
- Power consumption:** 0.22 W
- Battery life:** Main — Approximately 1 year (Approximately 100 hours by continuous use)
Memory protection — Approximately 1 year
- Auto power off:** Power is automatically switched off approximately 6 minutes after last operation.
- Ambient temperature range:** 0°C ~ 40°C (32°F ~ 104°F)
- Dimensions:** 15.6mmH × 81mmW × 172.5mmD (5/8" H × 3 3/4" W × 6 3/4" D)
- Weight:** 185.5g (6.5oz) including batteries (Rubber keys model)
179g (6.3oz) including batteries (Plastic keys model)

Index

A

Addition, 15
All clear (AC), 14, 26
Alpha functions, 11, 14, 15
Alpha lock, 11
And, 40, 82
Angular measurement, 14, 20,
70
Answer(Ans Function), 16, 28
Antilogarithm, 12, 72
Arithmetic calculations, 68
Array memory, 184
Auto power off, 197

B

BASE-n mode, 18, 38, 166
BASE-n mode calculations, 81
BASE-n, arithmetic operations,
81
BASE-n, conversions, 81
BASE-n, logical operations, 82
BASE-n, negative values, 81
Battery replacement, 195
Battery, memory back-up, 197
Binary, 38, 81

C

Cal mode, 18
Calculation priority sequence,
61
Calculation steps, 63
Change, 26
Clear graphic display, 60
Clear matrix, 48
Clear matrix memory, 25, 42
Clear memory, 24
Clear menu, 14, 24
Clear program, 17, 172
Clear program memory, 25
Clear statistical memories, 24
Clear text display, 60

Clear value memory, 36
CLR(clear), 14, 24
Combination, 76
COMP mode, 18
Computer math, 18, 81, 166
Conditional jumps, 179
Connect type graphs, 19, 138
Contrast, 18, 23
Coordinate conversion, 35, 75
Cosine, 13, 71
Count jumps, 180
Cube root, 13, 74
Cursor, 12

D

Decimal, 38, 81
Decimal places, 22, 79
Degrees, 14, 20, 70
Degrees-minutes-
seconds(DMS), 34
Delete, 15, 27
Determinant, 41, 54
Display format, 14, 20, 64, 79
Division, 15
DRAW mode, 19, 133, 136
Draw type, 19

E

Editing, 26
Engineering mode, 21
Engineering notation, 15
Engineering symbols, 14, 32,
78
Error messages, 28, 62, 64,
173, 205
Execute, 16
EXP mode, 18, 101
Exponent, 16, 63, 65
Exponential display, 64
Exponential functions, 12, 72
Exponential regression, 101, 109

Index

F

Factorial, 74
Fix, 22
Fractions, 13, 77
Function delete, 59
Function list, 58
Function memory, 14, 57
Function recall, 58
Function reference, 199
Function store, 57
Functions:Type A, 26, 30, 61
Functions:Type B, 26, 30, 61

G

Gradients/Grads, 14, 20
Graph type, 19
Graph, range, 112
Graph-Text key(G-T), 12
Graphic display, 60
Graphing, 12, 112
Graphing built-in scientific functions, 118
Graphing examples, 160
Graphing manually entered functions, 120, 123
Graphs, overdraw, 119, 120, 128

H

Hexadecimal, 38, 81
Hyperbolic functions, 33, 73
Hyperbolic functions, inverse, 73

I

Increasing value memories, 36, 134
INEQ mode, 19, 127
Inequality graphs, 19, 127
Initialize, 117, 159, 198
Input ranges, 207

Input value, 63
Inputting, 25
Insert, 15, 27
Integration calculations, 35, 84
Integration graphs, 130
Inverse matrix, 41, 55

J

Jump commands, 176, 178

K

Keyboard, 11

L

LIN mode, 18, 98, 107
Line, 146
Linear regression, 98, 107
ln, 12
LOG mode, 18, 100, 107
Logarithmic functions, 12, 72
Logarithmic regression, 100, 108
Logarithm, common, 12, 72
Logarithm, natural, 12, 72
Logical operations, 40, 82
Low battery message, 194

M

Main routine, 182
Mantissa, 63, 65
Manual calculations, 68, 199
Matrix delete, 48
Matrix addition, 43
Matrix arithmetic operation, 44
Matrix clear, 48
Matrix data input, 43
Matrix delete, 48
Matrix dimension, 41
Matrix exchange, 41, 56
Matrix mode, 18, 41, 166
Matrix multiplication, 46

Matrix size, 42
Matrix subtraction, 45
Matrix transposition, 41, 53
Matrix, inverse, 55
Memory calculations, 80
Memory remaining, 37, 134, 164, 174
Memory status check, 37
Memory steps, 63
Memory steps remaining, 174
Minus(-), 16
Mode display, 12
Mode key, 12
Mode menu, 17, 19
Modes, 12, 17
Multiplication, 15, 30
Multistatements, 29

N

Neg, 40, 81
Negative values, 15
Nesting, 182
Newline operation, 16, 176
No existence message, 48
Norm 1 (Norm 2) mode, 20, 64
Normal distribution curve, 135
Not, 40, 82
Numeric, 34

O

Octal, 38, 81
Off, 14
On, 14
Or, 40, 82
Output value, 63
Overflow, 64

P

Paired-variable statistics, 35, 97
Paired-variable statistical graphs, 136

PARAM mode, 19, 125
Parametric graphs, 19, 125
PCL mode, 17, 171
Permutation, 76
Pi, 16, 71, 115
Plot type graphs, 19, 138
Plot, point, 144
POL mode, 19, 122
Polar coordinates, 15, 75
Polar coordinates graphs, 19, 122
Power regression, 102, 110
Power supply, 194
Powers, 14
Previous key(PRE), 11, 33
Primary functions, 11
Probability, 33
Probability distribution graphs, 131
Program commands, 175
Program function menu, 175
Program steps, 174
Program, clear, 17, 172
Program, delete, 171
Program, edit, 170
Program, execute, 167
Program, input, 166
Program, memory, 165
Programming, 164
Punctuation symbol, 177
PWR mode, 18, 102, 110

R

Radians/rads, 14, 20, 70, 122
Range, 12, 112
Range parameter screen, 112
Reciprocal, 13, 74
REC mode, 19, 131
Rectangular coordinates, 15, 75
Rectangular coordinates graphs, 19, 118

Index

Index

REG mode, 18, 97, 136
 REG model, 18
 Regression, 97, 107
 Relational operator, 177
 Replay function, 12, 31
 Reset, 198
 Reset mode settings, 198
 Root, 14, 72
 RUN mode, 17

S

Scalar product, 41, 53
 Sci, 23
 Scientific functions, 33
 Scroll, 148
 Scrolling graphs, 142
 SD mode, 18, 92, 133
 Sexagesimal, 34
 Shift key, 11
 Shifted functions, 11
 Significant digits, 23, 79
 Sine, 13, 71, 118
 Single-variable statistics, 35, 90
 Single-variable statistical graphs, 133
 Specifications, 208
 Square key, 13, 74
 Square root key, 13, 74
 Standard deviation, 90, 105
 Stacks, 62
 Stat data, 19, 90
 Stat graph, 19
 Statistical calculations, 90
 Statistical calculations, paired variables, 35, 97
 Statistical calculations, single variable, 35, 90
 Statistics, edit data, 94
 Steps, 63, 174
 STO mode, 19, 92, 103
 Subroutines, 182

Subtraction, 15
 Sys mode, 17, 164

T

Tangent, 13, 71
 Text display, 60
 Text messages, 188
 Time calculation, 34
 Trace function, 138
 Transposition matrix, 41
 Trigonometric functions, 13, 71
 Trigonometric functions, inverse, 13, 71
 True algebraic logic, 61

U

Unconditional jumps, 178

V

Value memory, 35, 84, 184
 Variable key (X, θ , T) 12, 85, 119

W

WRT mode, 17, 170

















X

xnor, 40, 82
 xor, 40, 82



































Z

Zoom, 150
 Zoom, Box, 150
 Zoom, Factor, 153































Key Index

Key	Primary Function	combined with 	combined with 
 F1	Turns trace function on/off. Selects 1st function menu item.		
 F2	Turns zoom function on. Selects 2nd function menu item.		
 F3	Turns plot function on. Selects 3rd function menu item.		
 F4	Turns line function on. Selects 4th function menu item.		
 F5	Clears the graph screen. Selects 5th function menu item.		
 F6	Displays graph coordinates. Selects 6th function menu item.		
	Activates shift functions of other keys and function menus.		
 	Allows entry of alphanumeric characters shown in red.	Locks/Unlocks entry of alphanumeric characters.	
	Displays previous function menu level.		
	Displays mode selection screen.	Displays second mode selection screen.	
 	Switches display between graph & text screens.	Provides graphic integral solution.	
 	Activates graph function.	Displays math function menu.	Enters character r .
 	Displays range parameter input screen.	Displays menu of program commands.	Enters character θ .
	Displays current mode settings. (press & hold)		
	Moves cursor upward. Scrolls screen.	Switches to next function in trace mode.	
	Moves cursor downward. Scrolls screen.	Switches to next function in trace mode.	
	Moves cursor to left. Scrolls screen. Press after EXE to display calculation from end.		

Key Index

Key	Primary Function	combined with 	combined with 
	Moves cursor to right. Scrolls screen. Press after EXE to display calculation from beginning.		
$\int dx$  	Allows input of variables X, θ , and T.	Provides numerical integral solution.	Enters letter A.
10^x  	Press before entering value to calculate common logarithm.	Press before entering exponent value of 10.	Enters letter B.
e^x  	Press before entering value to calculate natural logarithm.	Press before entering exponent value of e.	Enters letter C.
\sin^{-1}  	Press before entering value to calculate sine.	Press before entering value to calculate inverse sine.	Enters letter D.
\cos^{-1}  	Press before entering value to calculate cosine.	Press before entering value to calculate inverse cosine.	Enters letter E.
\tan^{-1}  	Press before entering value to calculate tangent.	Press before entering value to calculate inverse tangent.	Enters letter F.
d/c  	Press between entering fraction values. Converts fraction to decimal.	Displays improper fraction.	Enters letter G.
x^2  	Press before entering value to calculate square root.	Press after entering value to calculate square.	Enters letter H.
$\sqrt[3]{\quad}$  	Enter open parenthesis in formula.	Press before entering value to calculate cube root.	Enters letter I.
x^{-1}  	Enter close parenthesis in formula.	Press after entering value to calculate reciprocal.	Enters letter J.
 	Assigns value to a value memory name.	Enters comma.	Enters letter K.
$\sqrt[x]{\quad}$  	Press between two values to make second value exponent of first.	Press between entering values for x & y to show xth root of y.	Enters letter L.
 	Enters number 7.		Enters letter M.
 	Enters number 8.		Enters letter N.
 	Enters number 9.		Enters letter O.
INS 	Deletes character at current cursor location.	Allows insertion of characters at cursor location.	

Key Index

Key	Primary Function	combined with 	combined with 
OFF 	Turns power on. Clears the display.	Turns power off.	
 	Enters number 4.		Enters letter P.
 	Enters number 5.		Enters letter Q.
ENG  	Enters number 6.	Displays menu of engineering symbols.	Enters letter R.
ENG  	Multiplication function.	Shifts decimal of display value 3 places to the left.	Enters letter S.
ENG  	Division function.	Shifts decimal of display value 3 places to right.	Enters letter T.
DRG  	Enters number 1.	Sets/converts unit of angular measurement.	Enters letter U.
DISP  	Enters number 2.	Displays menu of display format choices.	Enters letter V.
CL  	Enters number 3.	Displays memory clear menu.	Enters letter W.
Pol  	Addition function. Specifies positive value.	Transforms polar coordinates to rectangular.	Enters letter X.
Rec  	Subtraction function. Specifies negative value.	Transforms rectangular coordinates to polar.	Enters letter Y.
MEM  	Enters number 0.	Displays function memory menu.	Enters letter Z.
Defm  	Enters decimal point.	Shows memory status.	Enters open bracket.
π  	Allows entry of exponent.	Inputs value of pi. Enters pi symbol.	Enters close bracket.
(-) SPACE 	Recalls most recent calculation result.	Enter before value to specify as negative.	Enters a blank space.
	Displays result of calculation.	Inputs a new line.	

